

Cub Cadet®

Cub Cadet®

ENDURO SERIES™

FORCE SERIES

PRO SERIES

**PREVIEW
BROCHURE
2022**



ELECTRIC
LITHIUM ION

XR5
ENDURO SERIES™



As of 10/2021

MTD Products Aktiengesellschaft
Industriestraße 23 • 66129 Saarbrücken • GERMANY
www.mtdproducts.eu

© 2021 MTD Products Aktiengesellschaft, Germany. All rights reserved. Cub Cadet and other trademarks are registered trademarks of MTD Products Group. For more information, simply go to our website: www.cubcadet.eu. We reserve the right to make changes to prices, technical features and changes due to printing and other errors. All prices including VAT, as long as stocks last. Prices valid until 31st October 2022 (As of September, 2021).



CHAMPIONS – INSPIRED BY AMERICAN INGENUITY

Is it the power? The endurance? Or simply the fact, that you are ready for every challenge? There are many things that make Cub Cadet a true „champion“ - and they all have one thing in common: a revolutionary garden tractor introduced to the US in the 1960s.

Back then a true milestone and to this day a historic benchmark with regards to our standards and values: we continuously strive to exceed the high demands of our customers. With a mix of innovative engineering and user-friendly design, we want to inspire professionals, semi-professionals and ambitious outdoor enthusiast alike by creating pure products that are built for maximum efficiency, ease-of-use and maximum comfort.

That is what makes us proud - and turns you into a true champion.

Cub Cadet

OUR HISTORY KEEPS US GOING

1961 1 st Cub Cadet garden tractor hits the market	1963 1 st shaft drive model	1980 1 st super garden tractor	1980 1 st twin cylinder engine	1993 1 st steerable track drive snow thrower	2006 Utility vehicles debut	2009 Industry's tightest turning radius	2011 50th anniversary celebration with innovation	2014 Introduction of the innovative Boosted-Airflow-Technology	2017 Launch of the PRO SERIES – Zero-Turns	2018 Introduction of the XR ENDURO SERIES robotic mowers	2020 Launch of the XZ5 Zero-Turn series	2021 Introduction of the XR5 robotic mowers
1966 The world's 1 st garden tractor with hydrostatic transmission	1972 "Cadet" lawn tractor debuts	1985 Breaking new ground in cut quality	1994 1 st lawn tractor with shaft drive	2005 500 Series lawn tractors Made in Germany	2007 Synchro-Steer® Technology debuts, an Industry first	2010 Most advanced residential Zero-Turn	2015 MySpeed – The innovative variable speed system	2017 Introduction of the XT ENDURO SERIES lawn tractors	2020 Launch of LR2 E-rider and XT2 E-lawn tractor	2021 Introduction of the XZ7 Zero-Turn series	2021 Launch of the Zero-Turn PRO Z9	2022 Completion of the full electric line-up with the introduction of the LMS E 51 R electric lawn mower

NEW TO THE XR5 FAMILY: XR5 3000 & XR5 4000



Whatever the size or shape of your garden, we understand that it is your pride and joy. That's why the Cub Cadet XR5 has been designed to cut your lawn just like you would – with absolute precision.

From tackling uneven lawns to long grass and intricate edges, no lawn is too difficult for the XR5.

The two new models XR5 3000 and XR5 4000 are suitable for very large areas thanks to their double mowing deck that offers a staggering 42 cm cutting width.

Read more on page 6.

XZ6 ENDURO SERIES™



May we introduce the next evolution of ride-on zero-turn technology – the all-new XZ6. It combines all the great features of the XZ5 with the newest in steering wheel technology giving you the strength, performance and comfort you have learned to expect from a Cub Cadet rider.

A tubular steel frame that gives the mower the strength it needs and a fabricated mowing deck ensure unsurpassed mowing performance. The foot-operated deck lift and adjustable steering wheel column give you ultimate flexibility and full convenience for any task.

Read more on page 70.

NEW

OUR NEW ELECTRICAL RANGE. FULL POWER UNTIL THE FINAL TOUCH.

Endless opportunities, uncompromised capabilities, simplified ownership. From battery powered chainsaw to electrifying ride-on mowers, our brand new electric lineup is the perfect fit for your lawn and your lifestyle.

Read more on page 12.



THE XR5 IS DEVELOPED TO DELIVER QUALITY TIME AND TIME AGAIN, TO GIVE YOUR LAWN THAT PERFECT FLUFFY LOOK.



THE GARDENING ASSISTANT YOU'VE BEEN LOOKING FOR

The XR5 has been developed to cut your lawn with such precision that your neighbour will think you have cut your lawn yourself. The high quality steel blades cut your grass for maximum health and thickness so you get a luscious lawn with the time back to actually enjoy it.



1. BEAUTIFULLY FINISHED EDGES

Cutting beyond the edge of the wheel, the XR5 gives you a finish to be proud of, even on uneven surfaces.



2. HANDLES THICK GRASS AND UNEVEN TERRAIN

The reliable XR5 will never let you down. It doesn't get stuck and handles uneven terrain reliably.



3. EASY TO USE

From our easy to use interface and other features, including the charging station, Cub Cadet ensures that the XR5 is quick and easy to install.



4. EASY TO MAINTAIN

XR5 has been developed to self-clean, giving you more time in the garden. For complete peace of mind, you should arrange an annual maintenance service with your dealer.

COMPLETE CONTROL VIA SMARTPHONE

The App allows the robotic mowers in the XR ENDURO SERIES to be controlled and programmed securely and conveniently using your smartphone. Our recent BLE 5.0 upgrade now allows for faster data transfer of up to 2 MBps and greater outdoor range. Simply download the app, install it on your phone and get mowing.



DISCOVER THE NEW XR5!



REMOTE CONTROL

XR mowers can be manually controlled, even beyond the perimeter wire.



UPDATES

- Mowing progress
- Battery charge
- Mowing times

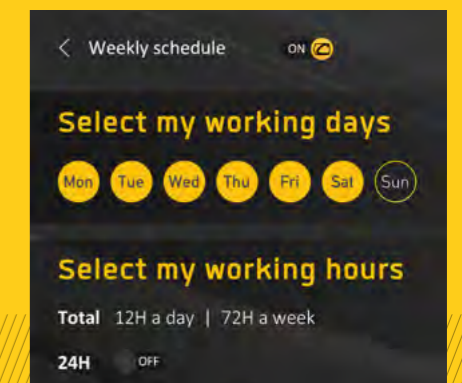

PROGRAM SETTINGS

- Mowing
- To charging station
- Deactivate automatic start
- Set mowing times

XR5 MOWING IN A CLASS OF THEIR OWN

From floating deck and superior slope handling to beyond-the-wheel edge cutting mode, the Cub Cadet XR5 range is packed with features that give your lawn a flawless finish. Latest addition to the 2022 line-up, are the new double mowing deck models for lawn areas of up to 4000 square meters. As for its smaller siblings, these new XR5s are also eligible for 1 free year additional warranty - protection against theft and vandalism included.

XR5 ENDURO SERIES™



XR5 1000	
Cutting width:	21 cm
Cutting height:	20-100 mm
Lawn area (rec.):	Up to 1.000 m ² *
Mowing time:	40-50 min
Engine:	DC Brushless
Power consumption:	4,0 kWh/month
Model no.:	22AKFEFA603
Price:	-

XR5 2000	
Cutting width:	21 cm
Cutting height:	20-100 mm
Lawn area (rec.):	Up to 2.000 m ² *
Mowing time:	80-90 min
Engine:	DC Brushless
Power consumption:	7,3 kWh/month
Model no.:	22AKHEFA603
Price:	-



DOUBLE DECK WITH 42 CM CUTTING WIDTH

XR5 3000	
Cutting width:	42 cm
Cutting height:	20-100 mm
Lawn area (rec.):	Up to 3.000 m ² *
Mowing time:	80-90 min
Engine:	DC Brushless
Power consumption:	8,7 kWh/month
Model no.:	22AKJEFA603
Price:	-

XR5 4000	
Cutting width:	42 cm
Cutting height:	20-100 mm
Lawn area (rec.):	Up to 4.000 m ² *
Mowing time:	110-120 min
Engine:	DC Brushless
Power consumption:	11,5 kWh/month
Model no.:	22AKLEFA603
Price:	-

*Max. mowing area under ideal mowing conditions: flat level lawn, simple rectangular shape, no obstacles, no additional zones, and modest lawn growing pace.

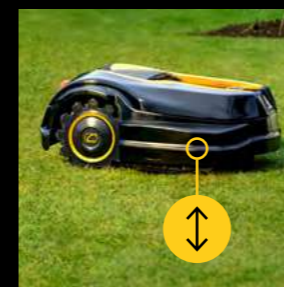

1. FLOATING DECK
A floating deck cuts uneven lawns flawlessly on any terrain, guaranteeing an excellent cut every time for even the most unusual landscapes.



2. SLOPE HANDLING
45% slope handling performance makes light work of the most challenging lawn setups.



3. 100 MM CUTTING HEIGHT
Tall, thick grass is not a problem with a 100 mm maximum cutting height.



4. PATENTED ALL TERRAIN WHEELS
Whatever your lawn surface looks like, the patented high traction, all-terrain wheels can navigate it smoothly and efficiently.

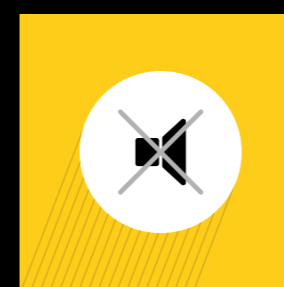

5. LOW NOISE
No more waiting for a sunny afternoon to tackle the lawn. Thanks to its drive motor, the XR5 is so quiet it could mow at night.



6. SELF-CLEANING
Self cleaning deck and wheels, making maintenance a breeze.



7. 4.3" TOUCHSCREEN
Set your mower to the exact setting you want with an easy-to-use 4.3" LCD touchscreen.



8. EDGE MODE TECHNOLOGY
The XR5's unique edging ability mows beyond the wheel to deliver a precise finish every time.



9. PATENTED CUTTING SYSTEM
Thanks to its patented cutting system you can have a great cut.



10. 360 DEGREE SENSOR
The XR5's omni-directional obstruction sensor ensures that it can navigate its way around any obstacle (please still make sure that there are no children or pets on the lawn while mowing).

3 YEARS**
Cub Cadet
WARRANTY

FREE 1-YEAR EXTENDED WARRANTY
available!
For more information visit www.cubcadet.eu

** Manufacturer's guarantee from MTD Products AG, limited to supplementary performance and according to the guarantee conditions (available at www.cubcadet.eu).

Images partly show previous year's models

TABLE OF PRODUCTS

	XR5 1000	XR5 2000
BATTERY		
Engine	DC Brushless	DC Brushless
Battery	18,15V Li-Ion	18,15V Li-Ion
Mowing time	40-50 min	80-90 min
Charging time	60-120 min	60-120 min
Power consumption	4,0 kWh/month	7,3 kWh/month
CUTTING SYSTEM		
Lawn area (rec.)	Up to 1.000 m ² *	Up to 2.000 m ² *
Cutting width	21 cm	21 cm
Cutting height (min.-max.)	20-100 mm	20-100 mm
Blades	4 cutting blades	4 cutting blades
Mowing zones	1 main zone, 4 sub zones, separate zones	1 main zone, 4 sub zones, separate zones
Area coverage per hour	65 m ² /h	65 m ² /h
Maximum inclination	24° / 45 %	24° / 45 %
EQUIPMENT		
Base station	Included	Included
RoboHome	Optional (122-085-603)	Optional (122-085-603)
Display	4,3" HD coloured touch	4,3" HD coloured touch
Bluetooth®	5.0	5.0
App	Standard	Standard
Anti-theft	Standard	Standard
Bump-Sensor	360° detection	360° detection
Tilt-Sensor	Standard	Standard
Lift-Sensor	Standard	Standard
Edge mode	Standard	Standard
GSM modul	Standard	Standard
Wheels	HIGH TRACTION all terrain wheels	HIGH TRACTION all terrain wheels
DIMENSIONS		
LpA/LwA/LwAg (dB)	50/61/64	50/61/64
Dimensions (L/W/H)	67 cm / 51 cm / 28	67 cm / 51 cm / 28
Net weight	23,0 kg (incl. packaging) kg	24,5 kg (incl. packaging) kg
PRICE		
Model number	22AKFEFA603	22AKHEFA603
EAN	 4 008423 917215	 4 008423 917246
Price	-	-

	NEW XR5 3000	NEW XR5 4000
BATTERY		
Engine	DC Brushless	DC Brushless
Battery	18,15V Li-Ion	18,15V Li-Ion
Mowing time	80-90 min	110-120 min
Charging time	60-80 min	90-110 min
Power consumption	8,7 kWh/month	11,5 kWh/month
CUTTING SYSTEM		
Lawn area (rec.)	Up to 3.000 m ² *	Up to 4.000 m ² *
Cutting width	42 cm	42 cm
Cutting height (min.-max.)	20-100 mm	20-100 mm
Blades	2 x 4 blades	2 x 4 blades
Mowing zones	1 main zone, 4 sub zones, separate zones	1 main zone, 4 sub zones, separate zones
Area coverage per hour	135 m ² /h	135 m ² /h
Maximum inclination	24° / 45 %	24° / 45 %
EQUIPMENT		
Base station	Included	Included
RoboHome	Optional (122-085-603)	Optional (122-085-603)
Display	4,3" HD coloured touch	4,3" HD coloured touch
Bluetooth®	5.0	5.0
App	Standard	Standard
Anti-theft	Standard	Standard
Bump-Sensor	360° detection	360° detection
Tilt-Sensor	Standard	Standard
Lift-Sensor	Standard	Standard
Edge mode	Standard	Standard
GSM modul	Standard	Standard
Wheels	HIGH TRACTION all terrain wheels	HIGH TRACTION all terrain wheels
DIMENSIONS		
LpA/LwA/LwAg (dB)	50/61/64	50/61/64
Dimensions (L/W/H)	67 cm / 53 cm / 28 cm	67 cm / 53 cm / 28 cm
Net weight	n.a. kg	n.a. kg
PRICE		
Model number	22AKJEFA603	22AKLEFA603
EAN	 4 008423 921250	 4 008423 921267
Price	-	-

ROBOTIC MOWER ACCESSORIES



PERIMETER SETTING

Perimeter wire (650 metres on spool)



Mod. no.: MRK0067B
Price: -



Installation Kit small (for max. 400 m²) 100 m wire, 150 pegs



Mod. no.: 122-001-603
Price: -



Installation Kit medium (for max. 1.200 m²) 150 m wire, 200 pegs



Mod. no.: 122-002-603
Price: -



Installation Kit large (for max. 2.500 m²) 250 m wire, 350 pegs



Mod. no.: 122-003-603
Price: -



REPLACEMENT BLADES

Blade kit XR5 models



Mod. no.: 122-105-603
Price: -



COVERS

RoboHome for XR5 models



Mod. no.: 122-085-603
Price: -



MORE POWER FOR YOUR WORLD

Lawn mower, string trimmer, hedge trimmer, chainsaw or leaf blower – each piece runs on an interchangeable lithium-ion battery so you can conveniently mix and match for enough power to finish the task at hand. They meet the rigorous standards for performance and durability you’ve come to expect from Cub Cadet equipment. Making it convenient to get all of your jobs done easier, with zero emissions and quieter than ever.



UNCOMPROMISING PERFORMANCE

Your lawn care depends on strong equipment, and our electric lineup won’t let you down. Each piece is engineered with the same uncompromising commitment to design, comfort and performance we demand from every product.



LESS MAINTENANCE



LONG RUNTIME



LOW CHARGE TIME



LOW NOISE



CUTS GRASS JUST LIKE GAS.

Think electric equipment compromises power? Think again. Our lithium-ion-powered electric lineup is proven to deliver the same results as our industry-leading gas models, resulting in the same premium cut quality you expect from Cub Cadet.



FULL POWER UNTIL THE FINAL TOUCH.

Unlike the lead-acid batteries in many riders, our lithium-ion battery pack eliminates power fade for the duration of its charge, while the efficient brushless motor ensures optimized power throughout.



100% ELECTRIC. 0% COMPROMISE.

Our electric lineup meets the same rigorous standards for performance, power and durability you’ll find in any Cub Cadet equipment.

LR2
FORCE SERIES



MOWING WITH POWER WHILE RESPECTING THE ENVIRONMENT

With the MINI-RIDER LR2 ES76, the MINI-RIDER segment is literally becoming new drive. This brand new model uses strong electric motors and is powered by a 56V Li-ION battery. Its large cutting width of 76 cm combined with 60 minutes of running time make the cutting of bigger lawns like a walk in the park. The MINI-RIDER LR2 ES76 comes with a 3 year warranty on both the mower and the battery.



Learn more

MOWING TIME 60 MIN*
4 HOURS CHARGING TIME

NEW



LR2 ES76	
Cutting width:	76 cm
Lawn area (rec.):	3.000 m ² /h
Collecting volume:	Optional 115 l
Engine:	Cub Cadet 56 V / 30 Ah / 1.500 Wh
Output Watts:	3,0 kW
Drive:	Electric drive
Cutting height adjustment:	5 positions
Model no.:	33BA27JD603
Price:	-

*Deviations are possible depending on lawn area

READY TO GO

Hop on and take off: Power and performance are always available – all year round!

ZERO EMISSIONS

The LR2 ES76 is particularly quiet and completely emission-free. This not only benefits the environment but also the neighbours.

MAINTENANCE- AND SERVICE-FRIENDLY

The electric motor needs no spark plugs, fuel filter and carburetor, which makes it much easier to maintain.

ULTRA-BRIGHT LED HEADLIGHTS

High visibility even when working at dawn or dusk.

NO REDUCTION OF PERFORMANCE WHILE BATTERY LEVELS DECREASE

SAFE-RETURN-FUNCTION

At a battery level of 10 %, the cutting deck automatically switches off making sure enough power remains to safely return to the charging station.

ELECTRONIC SPEED CONTROL

Works like cruise control and ensures that the selected pace remains constant, even in uneven terrain or in tall grass.

REVTEK™ TECHNOLOGY

The Reverse Mowing Technology allows you to continue mowing while backing up your MINI-RIDER. As a safety precaution this function must be activated manually.

LI-ION-POWER

Modern battery technology ensures a long service life as well as speedy charging cycles – once hooked up to an outlet, the battery is fully recharged within 4 hours.



Li-Ion
ELECTRIC

XT2™ ENDURO SERIES™



LI-ION-POWER

Modern battery technology ensures a long service life as well as speedy charging cycles – once hooked up to an outlet, the battery is fully recharged within 4 hours.



Learn more

MOWING TIME 90 MIN*
4 HOURS CHARGING TIME

NEW



XT2 ES107	
Cutting width:	107 cm
Lawn area (rec.):	8.000 m ² /h
Collecting volume:	Optional 200 l
Engine:	Cub Cadet 56 V / 60 Ah / 3.000 Wh
Output Watts:	3,0 kW
Drive:	Electric drive
Cutting height adjustment:	12 positions
Model no.:	33ABA7ES603
Price:	-

*Deviations are possible depending on lawn area

SUSTAINABLE ENERGY. STRONG POWER.

The XT Series flagship tractor platform is also combined with the advantages of e-mobility. Inside the XT2 ES107, powerful electric motors of the latest technology operate. Powered by a Li-ION battery with 56 V and a rated capacity of 60 Ah, this lawn tractor is as powerful as its petrol-powered relatives. With a running time of approx. 90 minutes, depending on lawn and soil conditions and a cutting width of 107 cm, even large lawns can be mastered quickly and in one piece. Also great: Cub Cadet gives you a 3-year warranty on the lawn tractor and the battery – longer than with hardly any other manufacturer!

ZERO EMISSIONS

The XT2 ES107 runs particularly quiet and with no emissions. This not only benefits the environment but also the neighbours.

SERVICE- AND MAINTENANCE-FRIENDLY

The electric motor does not contain any wearing parts such as spark plugs or fuel filters – these therefore do not need to be replaced.

NO REDUCTION OF PERFORMANCE WHILE BATTERY LEVELS DECREASE

17 cm
THE SMALLEST TURNING RADIUS ON THE MARKET
Innovative TIGHT TURN xTREME Technology for an unmatched 17 cm turning radius.

IMMEDIATE AVAILABILITY

Hop on and get started: Power and performance are always at your disposal – all year round.

USB-PORT

Charge your electronic devices while driving, for example your smartphone.

PARTICULARLY SMOOTH-RUNNING

A light touch of the pedal is all it takes for the electric mower to start moving smoothly. This lawn tractor is easier to drive than ever before.

SIDE DISCHARGE, COLLECT OR MULCH

The XT2 ES107 is a versatile companion – with its side discharge, an optional grass catcher or the optional mulching kit (accessory). Mulching and collecting may reduce the running time.



100 % ELECTRIC. 0 % COMPROMISE.

Think electric equipment compromises power? Think again. Our 60V MAX battery system will provide you with the premium cut quality and performance you expect in yardcare.

LH5 FORCE SERIES



- + AVAILABLE IN BOTH 2,5 AH AND 5,0 AH OPTIONS
- + ZERO EMISSIONS FROM EQUIPMENT'S POWER SOURCE
- + EASY AND RELIABLE PUSH TO START BUTTON – NO MORE PULLING CORDS
- + BRUSHLESS MOTOR MAXIMIZES EFFICIENCY AND EXTENDS LIFE OF MACHINE
- + UP TO 80% QUIETER THAN COMPARABLE GAS EQUIPMENT
- + ALL HAND TOOLS WITH PRACTICAL HOOK FOR SPACE-SAVING WALL STORAGE

60 VOLT MAX

NEW



EASY TO STORE
Space-saving design with folding handle for upright storage and easy cleaning.

Ultimate efficiency and robust design combined with the latest in battery technology. The noiseless and zero emissions LM5 cordless lawn mower sets you up for the future. Choose between collecting, mulching and side discharge – with first-class cut quality, as you have learned to expect from any Cub Cadet mower.



PREMIUM BALL BEARINGS
Ball bearings on all four wheels and rubber grips ensure a smooth ride.



VARIABLE DRIVE
Stepless speed control and rear-wheel drive make gardening much easier.



ROBUST STEEL MOWER DECK
The 53 cm wide steel cutting deck is suitable for uneven terrain.



6-FOLD CUTTING HEIGHT ADJUSTMENT
The cutting height can be conveniently adjusted centrally lever.



BOOSTED AIRFLOW TECHNOLOGY

BOOSTED AIRFLOW TECHNOLOGY
For optimal transport of the cuttings to the grass catcher.

LM5 E 51 R	
Cutting width:	51 cm
Lawn area (rec.):	700 m ² /h
Collecting volume:	60 l
Engine:	Battery 54V, Electric
Drive:	Rear wheel drive
Cutting height adjustment:	central
Model no.:	18ASTR94603
Price:	-



MORE POWER FOR YOUR GARDEN

The 60V MAX lithium-ion batteries are interchangeable throughout the range of equipment. If you have power left from one task, swap the battery with another machine to continue on.



60V BATTERY – BP 6025	
Capacity / Energy:	2,5 Ah / 135 Wh
Charging time:	2,5 Ah: 75 min
Weight:	1,2 kg
Model number:	49AP601-603
Price:	-



60 VOLT BATTERY – BP 6050	
Capacity / Energy:	5,0 Ah / 270 Wh
Charging time:	5,0 Ah: 60 min
Weight:	1,9 kg
Model number:	49AP602-603
Price:	-



60V CHARGER – BC 6020	
Charging current:	2,0 A
Weight:	0,7 kg
Model number:	49AL601-603
Price:	-

- Cruise control to set the speed
- Highly efficient brushless motor with maximum service life
- Axial fan delivery up to 180 km/h of power



60V LEAF BLOWER – LH5 B60	
Running time:	Up to 90 min with 2,5 Ah battery
Charging time:	2,5 Ah: 75 min / 5,0 Ah: 150 min
Speed (max.):	up to 180 km/h
Air flow:	up to 1.080 m³/h
Axial fan:	Standard
Weight without/with battery:	2,5 / 3,7 kg (with 2,5 Ah battery)
Model number:	41AT6BE-603
Price (without battery):	-

- Tool-free chain change and chain tensioning
- Spirit level allows precise and level cutting
- High-efficiency brushless motor optimizes power, performance and longevity



60V CHAIN SAW – LH5 C60	
Running time:	Up to 80 min with 2,5 Ah battery
Charging time:	2,5 Ah: 75 min / 5,0 Ah: 150 min
Blade length:	40 cm
Chain speed:	13,5 m/s
Chain pitch:	3/8"
Weight without/with battery:	4,4 / 5,6 kg (with 2,5 Ah battery)
Model number:	41AT6CGR603
Price (without battery):	-

60V TRIMMER – LH5 T60	
Running time:	45 min with 2,5 Ah battery
Charging time:	2,5 Ah: 75 min / 5,0 Ah: 150 min
Cutting width:	33 cm
Line thickness:	∅ 2,0 mm, double
Telescopic tube:	Standard
Weight without/with battery:	3,6 / 4,8 kg (with 2,5 Ah battery)
Model number:	41AT6TGT603
Price (without battery):	-





- Two-stage speed control
- Line can be replaced with spool attached
- Lightweight design – 4,8 kg with battery



60V HEDGE TRIMMER – LH5 H60	
Running time:	80 min with 2,5 Ah battery
Charging time:	2,5 Ah: 75 min / 5,0 Ah: 150 min
Cutting movements (max.):	1.500/min
Blade length:	60 cm
Blade spacing:	19 mm
Weight without/with battery:	3,4 / 4,6 kg (with 2,5 Ah battery)
Model number:	41AT6HK-603
Price (without battery):	-



- Laser cut blade
- Oscillating saw at the end of the knife
- Full-bale handle maximizes maneuverability and reduces vibration



	LH5 B60	LH5 H60	LH5 T60
BATTERY			
Battery/Charger	2,5 Ah (49AP601-603) or 5,0 Ah (49AP602-603)/(49AL601-603)	2,5 Ah (49AP601-603) or 5,0 Ah (49AP602-603)/(49AL601-603)	2,5 Ah (49AP601-603) or 5,0 Ah (49AP602-603)/(49AL601-603)
Runtime	Up to 90 min with 2,5 Ah battery	80 min with 2,5 Ah battery	45 min with 2,5 Ah battery
Charging time/charging cycles	2,5 Ah: 75 min / 5,0 Ah: 150 min	2,5 Ah: 75 min / 5,0 Ah: 150 min	2,5 Ah: 75 min / 5,0 Ah: 150 min
Voltage	54 V	54 V	54 V
FEATURES			
Speed (max.)	up to 180 km/h	-	-
Air flow	up to 1.080 m³/h	-	-
Speed stages	Stepless	-	-
Cutting movements (max.)	-	1.500/min	-
Blade length	-	60 cm	-
Cutting width	-	19 mm	33 cm
Chain speed	-	-	-
Line thickness	-	-	∅ 2,0 mm, double
Line spool	-	-	Easy winding without removing the reel
MAIN FEATURES			
Axial fan	Standard	-	-
Comfort handle	-	Standard	Standard
Dual action blades	-	Standard	-
DIMENSIONS			
LpA/LwA/LwAg (dB)	89/101/103	79,5/91,5/95	79,5/93/96
Vibration value hand/arm / K-factor	2,5 / 1,5 m/s²	3,0 / 1,5 m/s²	3,5 / 1,5 m/s²
Dimensions (L/W/H)	53 cm / 32 cm / 23 cm	106 cm / 26 cm / 24 cm	106 cm / 26 cm / 24 cm
Net weight	2,5 / 3,7 kg (with 2,5 Ah battery)	3,4 / 4,6 kg (with 2,5 Ah battery)	3,6 / 4,8 kg (with 2,5 Ah battery)
PRICE			
Model number	41AT6BE-603	41AT6HK-603	41AT6TG-603
EAN	 4 008423 917345	 4 008423 917369	 4 008423 917376
Price	-	-	-

	BP 6025	BP 6050	BC 6020
Capacity / Energy	2,5 Ah / 135 Wh	5,0 Ah / 270 Wh	2,0 A Charging current
Model number	49AP601-603	49AP602-603	49AL601-603
EAN	 4 008423 917383	 4 008423 917390	 4 008423 917406
Price	-	-	-

	LH5 C60
BATTERY	
Battery/Charger	2,5 Ah (49AP601-603) or 5,0 Ah (49AP602-603)/(49AL601-603)
Runtime	Up to 80 min with 2,5 Ah battery
Charging time/charging cycles	2,5 Ah: 75 min / 5,0 Ah: 150 min
Voltage	54 V
FEATURES	
Speed (max.)	-
Air flow	-
Speed stages	-
Cutting movements (max.)	-
Blade length	40 cm
Cutting width	-
Chain speed	13,5 m/s
Line thickness	-
Line spool	-
MAIN FEATURES	
Axial fan	-
Comfort handle	-
Dual action blades	-
DIMENSIONS	
LpA/LwA/LwAg (dB)	91/102/104
Vibration value hand/arm / K-factor	3,5 / 1,5 m/s²
Dimensions (L/W/H)	93 / 29 / 27
Net weight	4,4 / 5,6 kg (with 2,5 Ah battery)
PRICE	
Model number	41AT6CGR603
EAN	 4 008423 917352
Price	-

OVERVIEW TABLES FOR THE E-RIDER:

- LR2 ES76 can be found on [page 41](#)
- XT2 ES107 can be found on [page 61](#)

	LM5 E 51 R
BATTERY	
Battery/Charger	optional 5,0 Ah (49AP602-603)
Runtime	30 min (with 5,0 Ah battery)
Charging time/charging cycles	Battery 5,0 Ah: 150 min
Engine	Battery 54V
DRIVE SYSTEM	
Drive	Rear wheel drive
Driving stages	variable
Speed (max.)	variable
CUTTING SYSTEM	
Lawn area (rec./up to)	700 m²/h
Housing (material)	Steel
Cutting width	51 cm
Mowing options	3-in-1
Cutting height adjustment	central
Cutting height (min/max)	38-88 mm
Bagging	inclusive
Mulch Kit	inclusive
Side discharge	-
Rear discharge without grass catcher	Standard
DISCHARGE SYSTEM	
Grass catcher	Soft bag
Grass catcher (capacity)	60 l
Filling level indicator	-
WHEELS	
Wheels (f/r)	150 mm / 200 mm
Wheel bearing	double ball bearings
COMFORT	
Cutting deck washing nozzle	-
Bar	Ergo with softgrip
Folding bar	Standard
Height-adjustable bar	Standard, 3 steps
Soft-Grip	Standard
DIMENSIONS	
LpA/LwA/LwAg (dB)	n.a./n.a./n.a.
Vibration value hand/arm / K-factor	2,5 / 1,5 m/s²
Dimensions (L/W/H)	160 cm / 56 cm / 110 cm
Net weight	32 kg
PRICE	
Model number	18ASTR94603
EAN	 4 008423 921878
Price	-

LM1
FORCE SERIES

3-in-1
OPTION

REAR DISCHARGER,
COLLECTING &
OPTIONAL MULCHING

To change your lawn mower from discharging mode to mulching, simply engage the optionally available mulching wedge.



CENTRAL CUTTING HEIGHT ADJUSTMENT
Comfortably change the cutting height centrally with one lever – choose from 6 different positions.

ERGONOMIC HANDLEBAR
The ergonomic handlebar is height adjustable and fully foldable, making the mower particularly easy to store.

LM SERIES – PERFECT CUT AND BAGGING

High efficiency alongside typical Cub Cadet quality – this is where Cub Cadet lawn mowers come into play. A durable construction extends the service life, while the Cub Cadet OHV engine delivers the right power to meet your needs. The Cub Cadet LM Series gives you the choice between bagging and discharging the clippings. A mulch kit is also available as an accessory, giving you the option of mulching your lawn. Many ergonomic features help get the job done while reducing stress – the easy-empty grass catcher, the ergonomically shaped handlebar, the convenient central height adjustment and the ball bearing wheels all help enhance the comfort even more.



LARGE GRASS CATCHER
A large grass catcher reduces the number of dump runs. Saving you time – fewer trips to/from the compost heap.



SELF-PROPELLED
Self-propelled mowers enable easy mowing on uneven and sloping terrain. MySpeed models can adapt to your personal pace (LM2 and LM3 series).



LM1 AP46	
Cutting width:	46 cm
Lawn area (rec.):	700 m ² /h
Collecting volume:	60 l
Engine:	Cub Cadet 35 OHV, Pull starter
Engine displacement:	79 cm ³
Drive:	Pushed
Cutting height adjustment:	6 positions/central
Model no.:	11C-TQMG603
Price:	-



LM1 AR46	
Cutting width:	46 cm
Lawn area (rec.):	700 m ² /h
Collecting volume:	60 l
Engine:	Cub Cadet 35 OHV, Pull starter
Engine displacement:	79 cm ³
Drive:	Rear-wheel drive
Cutting height adjustment:	6 positions/central
Model no.:	12C-TQMG603
Price:	-



LM1 CR53	
Cutting width:	53 cm
Lawn area (rec.):	950 m ² /h
Collecting volume:	70 l
Engine:	Cub Cadet 45 OHV, Pull starter
Engine displacement:	140 cm ³
Drive:	Rear-wheel drive
Cutting height adjustment:	6 positions/central
Model no.:	12D-PQSC603
Price:	-



LM1 DP53	
Cutting width:	53 cm
Lawn area (rec.):	950 m ² /h
Collecting volume:	70 l
Engine:	Cub Cadet 55 OHV, Pull starter
Engine displacement:	159 cm ³
Drive:	Pushed
Cutting height adjustment:	6 positions/central
Model no.:	11E-PTKC603
Price:	-

LM2
FORCE SERIES

3-in-1

**REAR DISCHARGER
COLLECTING & MULCHING**

Select the right mowing method for your Cub Cadet lawn mower with a simple flick of the wrist. Whether collecting clippings, discharging them from the rear or mulching – all options are easily selectable on this mower.

ELECTRIC START
Electric start gives you maximum comfort. Start your lawn mower at the turn of a key.

HEIGHT ADJUSTABLE HANDLE
Adapt the ergonomic handlebar to your height of choice, for comfortable mowing free of stress and fatigue.

CENTRAL CUTTING HEIGHT ADJUSTMENT
One grip to adjust all four wheels simultaneously. Less effort and time taken, matchless comfort.

LARGE GRASS CATCHER
A large grass catcher reduces the number of dump runs. Saving you time – fewer trips to/from the compost heap.



LM2 SERIES – POWERFUL AND COMFORTABLE

Our LM2 series mowers come with powerful Cub Cadet engines and many comfort features. First and foremost, there's the MySpeed wheel drive, which makes mowing incredibly comfortable and flexible. Simply walk at your own pace, and the LM2 series mower will follow your lead.



3-in-1
POWERED BY
Cub Cadet
MYSPEED

LM2 DR46s

Cutting width:	46 cm
Lawn area (rec.):	750 m ² /h
Collecting volume:	60 l
Engine:	Cub Cadet 55 OHV, Pull starter/AutoChoke
Engine displacement:	159 cm ³
Drive:	Rear-wheel drive
Cutting height adjustment:	6 positions/central
Model no.:	12EBTQKC603
Price:	-



3-in-1
POWERED BY
Cub Cadet
MYSPEED

LM2 DR46es

Cutting width:	46 cm
Lawn area (rec.):	750 m ² /h
Collecting volume:	60 l
Engine:	Cub Cadet 55 OHV, Electric
Engine displacement:	159 cm ³
Drive:	Rear-wheel drive
Cutting height adjustment:	6 positions/central
Model no.:	12ECTQS7603
Price:	-



3-in-1
POWERED BY
Cub Cadet
MYSPEED

LM2 DR53s

Cutting width:	53 cm
Lawn area (rec.):	950 m ² /h
Collecting volume:	70 l
Engine:	Cub Cadet 55 OHV, Pull starter/AutoChoke
Engine displacement:	159 cm ³
Drive:	Rear-wheel drive
Cutting height adjustment:	6 positions/central
Model no.:	12EBPQKC603
Price:	-

4-in-1

REAR BAGGING, MULCHING, SIDE & REAR DISCHARGE

4-in-1 gives you optimal mower flexibility with four usage modes. You can attach a side deflector to the deck and turn the unit into a side-discharging mower. You can operate it as a rear-discharger or attach a collecting bag – or use the mulching option as the fourth operation option. Giving you freedom to select the ideal discharge solution, whatever the condition.



LM3 SERIES - STRONG PERFORMANCE AND MAXIMUM FLEXIBILITY

The flagship models of the LM Series will impress you with superb features: a range of powerful engines for rapid mowing, the 4-in-1 system for total flexibility in mowing options, variable driving speed with MySpeed now available on all models and many more convenient features.



MYSPEED DRIVE SYSTEM
LM3 series is equipped with the MySpeed Drive System, which automatically switches on as soon as you push the handle. The speed automatically adjusts to your walking speed.



EASY STARTING B&S ENGINE
The Briggs & Stratton engines with ReadyStart® Technology and Start Guarantee® let you start the mower more easily and confidently.



POWERFUL ENGINE
All LM3 series lawn mowers are equipped with extremely powerful Cub Cadet OHV, Kawasaki or Briggs & Stratton engines, which always bring out the maximum power.



HIGH REAR WHEELS
High rear wheels to negotiate pot-holes and uneven lawns effortlessly. For ultra-comfortable handling and smooth driving.



A HARD-TOP BAG WITH A FILL INDICATOR
The dustproof hard-top catcher with fill indicator means less dust during dry periods, while the fill indicator flap indicates when the grass catcher is full and needs emptying.



4-in-1
POWERED BY
Cub Cadet
MYSPEED

LM3 CR46s	
Cutting width:	46 cm
Lawn area (rec.):	750 m ² /h
Collecting volume:	60 l
Engine:	B&S 575 EX-Series, ReadyStart®, Pull starter
Engine displacement:	140 cm ³
Drive:	Rear-wheel drive
Cutting height adjustment:	6 positions/central
Model no.:	12EBTV5E603
Price:	-



4-in-1
POWERED BY
Cub Cadet
MYSPEED

LM3 CRC46s	
Cutting width:	46 cm
Lawn area (rec.):	750 m ² /h
Collecting volume:	60 l
Engine:	Cub Cadet 45 OHV, Pull starter
Engine displacement:	140 cm ³
Drive:	Rear-wheel drive
Cutting height adjustment:	6 positions/central
Model no.:	12DBTVSC603
Price:	-



4-in-1
POWERED BY
Cub Cadet
MYSPEED

LM3 CR53s	
Cutting width:	53 cm
Lawn area (rec.):	950 m ² /h
Collecting volume:	70 l
Engine:	B&S 750 EX DOV Series, Pull starter
Engine displacement:	161 cm ³
Drive:	Rear-wheel drive
Cutting height adjustment:	6 positions/central
Model no.:	12DBPV5L603
Price:	-



4-in-1
POWERED BY
Cub Cadet
MYSPEED

LM3 DR53es	
Cutting width:	53 cm
Lawn area (rec.):	950 m ² /h
Collecting volume:	70 l
Engine:	Cub Cadet 55 OHV ES, Electric
Engine displacement:	159 cm ³
Drive:	Rear-wheel drive
Cutting height adjustment:	6 positions/central
Model no.:	12ECPVS7603
Price:	-

STRONG ENOUGH TO CUT EVERYTHING

The Cub Cadet LC3 DP56 mobile lawn trimmer is so strong it meets any challenge – however tough the conditions. With the powerful Cub Cadet engine and ultra-large, 56-cm cutting width, trim long grass and weeds at a stroke, just as if mowing short grass.

LC3 DP56	
Cutting width:	56 cm
Cutting height:	60–110 mm
Line:	Ø 3,9 mm
Engine:	Cub Cadet 55 OHV
Wheels:	Ø 360 mm
Drive:	Pushed
Net weight:	31 kg
Model no.:	25C-262E603
Price:	-



REPLACEMENT LINE FOR LC3 DP56



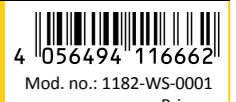





10 pcs. of cutting line AF3.20, cut to 3,9 mm x 47 cm length





4 056494 116662
Mod. no.: 1182-WS-0001
Price: -

	LM1 AP46	LM1 AR46	LM1 CR53
ENGINE			
Engine type	Cub Cadet 35 OHV	Cub Cadet 35 OHV	Cub Cadet 45 OHV
Engine displacement	79 cm ³	79 cm ³	140 cm ³
Rated power	1,5 kW / 2.800 min ⁻¹	1,5 kW / 2.800 min ⁻¹	2,1 kW / 2.800 min ⁻¹
Engine start	Pull starter	Pull starter	Pull starter
Tank volume (capacity)	0,75 l	0,75 l	1,0 l
DRIVE SYSTEM			
Drive	Pushed	Rear-wheel drive	Rear-wheel drive
Selectable speeds	–	1	1
Speed (max)	–	3,6 km/h	3,6 km/h
CUTTING SYSTEM			
Lawn area (rec./up to)	700 m ² /h	700 m ² /h	950 m ² /h
Cutting deck (material)	Steel	Steel	Steel
Cutting width	46 cm	46 cm	53 cm
Cutting options	3-in-1 Option	3-in-1 Option	3-in-1 Option
Cutting height adjustment	6 positions/central	6 positions/central	6 positions/central
Cutting height (min–max)	28–92 mm	28–92 mm	28–92 mm
Bagging	Standard	Standard	Standard
Mulch Kit	Optional (196-588-678)	Optional (196-588-678)	Optional (196-589-678)
Side discharge	–	–	–
Rear discharge without collector	Standard	Standard	Standard
BAGGING			
Gras catcher type	Soft bag	Soft bag	Soft bag
Collecting volume	60 l	60 l	70 l
Bag fill indicator	–	–	–
WHEELS			
Wheels (F/R)	180 mm / 200 mm	180 mm / 200 mm	200 mm / 200 mm
Wheel bearing	double ball bearings	double ball bearings	double ball bearings
COMFORT			
Washing nozzle	Standard	Standard	Standard
Handlebar type	Ergonomic	Ergonomic	Ergonomic
Foldable handlebar	Standard	Standard	Standard
Height adjustable handlebar	Standard	Standard	Standard
Soft-Grip	Standard	Standard	Standard
DIMENSIONS			
LpA/LwA/LwAg (dB)	84/94/96	84/94/96	86/96/98
Vibration value hand/arm / K-factor	5,0 / 1,5 m/s ²	5,0 / 1,5 m/s ²	5,0 / 1,5 m/s ²
Dimensions (L/W/H)	155 cm / 49 cm / 114 cm	155 cm / 49 cm / 114 cm	162 cm / 58 cm / 114 cm
Net weight	28 kg	31 kg	34 kg
PRICE			
Model number	11C-TQMG603	12C-TQMG603	12D-PQSC603
EAN	 4 008423 892390	 4 008423 892406	 4 008423 872637
Price	–	–	–

	LM1 DP53	LM2 DR46s	LM2 DR46es
ENGINE			
Engine type	Cub Cadet 55 OHV	Cub Cadet 55 OHV	Cub Cadet 55 OHV
Engine displacement	159 cm ³	159 cm ³	159 cm ³
Rated power	2,5 kW / 2800 min ⁻¹	2,5 kW / 2.800 min ⁻¹	2,5 kW / 2.800 min ⁻¹
Engine start	Pull starter	Pull starter/AutoChoke	Electric
Tank volume (capacity)	1,0 l	1,0 l	1,0 l
DRIVE SYSTEM			
Drive	Pushed	Rear-wheel drive	Rear-wheel drive
Selectable speeds	–	Variable	Variable
Speed (max)	– km/h	0–3,6 km/h	0–3,6 km/h
CUTTING SYSTEM			
Lawn area (rec./up to)	950 m ² /h	750 m ² /h	750 m ² /h
Cutting deck (material)	Steel	Steel	Steel
Cutting width	53 cm	46 cm	46 cm
Cutting options	4-in-1	3-in-1	3-in-1
Cutting height adjustment	6 positions/central	6 positions/central	6 positions/central
Cutting height (min–max)	28–92 mm	28–92 mm	28–92 mm
Bagging	Standard	Standard	Standard
Mulch Kit	Standard	Standard	Standard
Side discharge	Standard	–	–
Rear discharge without collector	Standard	Standard	Standard
BAGGING			
Gras catcher type	Soft bag	Soft bag	Soft bag
Collecting volume	70 l	60 l	60 l
Bag fill indicator	–	–	–
WHEELS			
Wheels (F/R)	200 mm / 280 mm	180 mm / 200 mm	180 mm / 200 mm
Wheel bearing	double ball bearings	double ball bearings	double ball bearings
COMFORT			
Washing nozzle	Standard	Standard	Standard
Handlebar type	Ergonomic	MySpeed	MySpeed
Foldable handlebar	Standard	Standard	Standard
Height adjustable handlebar	Standard	Standard	Standard
Soft-Grip	Standard	–	–
DIMENSIONS			
LpA/LwA/LwAg (dB)	86/96/98	84/94/96	84/94/96
Vibration value hand/arm / K-factor	5,0 / 1,5 m/s ²	5,0 / 1,5 m/s ²	5,0 / 1,5 m/s ²
Dimensions (L/W/H)	– cm / – cm / – cm	150 cm / 49 cm / 114 cm	150 cm / 49 cm / 114 cm
Net weight	39 kg	31 kg	35 kg
PRICE			
Model number	11E-PTKC603	12EBTQKC603	12ECTQS7603
EAN	 4 008423 877007	 4 008423 866148	 4 008423 866247
Price	–	–	–

	LM2 DR53s	LM3 CR46s	LM3 CRC46s
ENGINE			
Engine type	Cub Cadet 55 OHV	B&S 575 EX-Series, ReadyStart®	Cub Cadet 45 OHV
Engine displacement	159 cm³	140 cm³	140 cm³
Rated power	2,5 kW / 2.600 min ⁻¹	2,1 kW / 2.800 min ⁻¹	2,1 kW / 2.800 min ⁻¹
Engine start	Pull starter/AutoChoke	Pull starter	Pull starter
Tank volume (capacity)	1,0 l	0,8 l	1,0 l
DRIVE SYSTEM			
Drive	Rear-wheel drive	Rear-wheel drive	Rear-wheel drive
Selectable speeds	Variable	Variable	Variable
Speed (max)	0–3,6	0–3,6 km/h	0–3,6 km/h
CUTTING SYSTEM			
Lawn area (rec./up to)	950 m²/h	750 m²/h	750 m²/h
Cutting deck (material)	Steel	Steel	Steel
Cutting width	53 cm	46 cm	46 cm
Cutting options	3-in-1	4-in-1	4-in-1
Cutting height adjustment	6 positions/central	6 positions/central	6 positions/central
Cutting height (min–max)	28–92 mm	28–92 mm	28–92 mm
Bagging	Standard	Standard	Standard
Mulch Kit	Standard	Standard	Standard
Side discharge	–	Standard	Standard
Rear discharge without collector	Standard	Standard	Standard
BAGGING			
Gras catcher type	Soft bag	Soft bag with hard top	Soft bag with hard top
Collecting volume	70 l	60 l	60 l
Bag fill indicator	–	Standard	Standard
WHEELS			
Wheels (F/R)	200 mm / 280 mm	180 mm / 280 mm	180 mm / 280 mm
Wheel bearing	double ball bearings	double ball bearings	double ball bearings
COMFORT			
Washing nozzle	Standard	Standard	Standard
Handlebar type	MySpeed	MySpeed	MySpeed
Foldable handlebar	Standard	Standard	Standard
Height adjustable handlebar	Standard	Standard	Standard
Soft-Grip	–	–	–
DIMENSIONS			
LpA/LwA/LwAg (dB)	86/96/98	84/94/96	84/94/96
Vibration value hand/arm / K-factor	5,0 / 1,5 m/s²	5,0 / 1,5 m/s²	5,0 / 1,5 m/s²
Dimensions (L/W/H)	162 cm / 58 cm / 114 cm	155 cm / 49 cm / 114 cm	155 cm / 49 cm / 114 cm
Net weight	34 kg	34 kg	34 kg
PRICE			
Model number	12EBPQKC603	12EBTV5E603	12DBTVSC603
EAN	 4 008423 866131	 4 008423 859324	 4 008423 877045
Price	–	–	–

	LM3 CR53s	LM3 DR53es	LC3 DP56
ENGINE			
Engine type	B&S 750 EX DOV Series	Cub Cadet 55 OHV ES	Cub Cadet 55 OHV
Engine displacement	161 cm³	159 cm³	159 cm³
Rated power	n.v. kW / n.v. min ⁻¹	2,5 kW / 2.600 min ⁻¹	2,1 kW / 2.800 min ⁻¹
Engine start	Pull starter	Electric	Pull starter
Tank volume (capacity)	1,0 l	1,0 l	1,0 l
DRIVE SYSTEM			
Drive	Rear-wheel drive	Rear-wheel drive	Pushed
Selectable speeds	Variable	Variable	–
Speed (max)	0–3,6 km/h	0–3,6 km/h	–
CUTTING SYSTEM			
Lawn area (rec./up to)	950 m²/h	950 m²/h	1.000 m²/h
Cutting deck (material)	Steel	Steel	–
Cutting width	53 cm	53 cm	56 cm
Cutting options	4-in-1	4-in-1	–
Cutting height adjustment	6 positions/central	6 positions/central	–
Cutting height (min–max)	28–92 mm	28–92 mm	60–110 mm
Bagging	Standard	Standard	–
Mulch Kit	Standard	Standard	–
Side discharge	Standard	Standard	–
Rear discharge without collector	Standard	Standard	–
BAGGING			
Gras catcher type	Soft bag with hard top	Soft bag with hard top	–
Collecting volume	70 l	70 l	–
Bag fill indicator	Standard	Standard	–
WHEELS			
Wheels (F/R)	200 mm / 280 mm	200 mm / 280 mm	∅ 360 mm
Wheel bearing	double ball bearings	double ball bearings	Slide bearings
COMFORT			
Washing nozzle	Standard	Standard	–
Handlebar type	MySpeed	MySpeed	3 positions
Foldable handlebar	Standard	Standard	–
Height adjustable handlebar	Standard	Standard	–
Soft-Grip	–	–	–
DIMENSIONS			
LpA/LwA/LwAg (dB)	86/96/98	86/96/98	93/106/108
Vibration value hand/arm / K-factor	5,0 / 1,5 m/s²	5,0 / 1,5 m/s²	6,5 / 1,5 m/s²
Dimensions (L/W/H)	162 cm / 58 cm / 114 cm	162 cm / 58 cm / 114 cm	140 cm / 55 cm / 100 cm
Net weight	36 kg	41 kg	31 kg
PRICE			
Model number	12DBPV5L603	12ECPV57603	25C-262E603
EAN	 4 008423 859355	 4 008423 866155	 4 008423 881967
Price	–	–	–



Learn more

LR1 FORCE SERIES

200 LITRE GRASS CATCHER

A 200 litre grass catcher bag (models LR1 MR76 and LR2 NR76) with dust protection cover, two grips and fill indicator. Can be emptied from the driver's seat.

4,9 LITRE FUEL TANK

The large fuel tank with fuel indicator gives you the freedom to mow your lawn in a full cycle – no refuel needed.

LARGE TYRES

Lawn-friendly, yet handy, even on uneven terrain.

STEP-THROUGH FRAME

With soft rubber foot pads, for easy access and comfortable foot rest.

CUTTING HEIGHT ADJUSTMENT & PTO CLUTCH

Easily adjustable cutting height over 5 positions, from 38 to 95 mm. Both levers are located ergonomically on the right side of the seat.



COMPACT AND VERSATILE LIKE NEVER BEFORE

Modern design, versatility and comfortable mowing – just three of the many reasons to go for the Cub Cadet MINI-RIDER. The compact and manoeuvrable Cub Cadet MINI-RIDER models with electric start are equipped with one of the powerful and low-maintenance Cub Cadet engines.

If you want to collect, discharge or mulch your grass clippings, this is your go-to mower. Thanks to their space saving design, these Cub Cadet MINI-RIDER models are almost as compact as a conventional walk behind mower in terms of garage space.



TRANSMATIC TRANSMISSION

The transmatic transmission allows shift-on-the-go speed control. Simply choose your driving direction, set the desired basic speed and start mowing. On the Cub Cadet MINI-RIDER LR1 MR76, select between 6 forward and 6 reverse speeds.



76 CM MOWING DECK

Selectable collecting, mulching and discharge options come as standard with model LR1 MR76. The model LR1 MS76 offers mulching and side discharge options. Superior mulching, excellent collection and side discharge for spreading. Whatever you choose, the MINI-RIDER can handle it. Thanks to the new blade design, you now achieve even better collection results.



The German garden magazine „Familienheim und Garten“ awarded the MINI-RIDER LR1 MR76 a „good“ verdict in testing.

The unit convinced in terms of performance and versatility in particular. The electric start and a large fuel tank of approx. 5 litres allow mowing for extended periods without having to refuel.



LR1 MR76

Cutting width:	76 cm
Lawn area (rec.):	2.500 m ² /h
Collecting volume:	Standard 200 l
Engine:	Cub Cadet OHV
Engine displacement:	382 cm ³
Drive:	Transmatic
Cutting height adjustment:	5 positions
Model no.:	13B726HD603
Price:	-



LR1 MS76

Cutting width:	76 cm
Lawn area (rec.):	3.000 m ² /h
Collecting volume:	Optional 115 l
Engine:	Cub Cadet OHV
Engine displacement:	382 cm ³
Drive:	Transmatic
Cutting height adjustment:	5 positions
Model no.:	13B726JD603
Price:	-

THE SIZE YOU NEED WITH THE POWER YOU WANT

The Cub Cadet MINI-RIDER LR2 delivers all the strength, durability and cutting performance of larger rider models; but in a more compact design. An even more powerful engine with auto-choke, premium hydrostatic transmission and the exclusive steering wheel system gives you optimum control while in operation.



LR2 NR76	
Cutting width:	76 cm
Lawn area (rec.):	2.500 m ² /h
Collecting volume:	Standard 200 l
Engine:	Cub Cadet OHV
Engine displacement:	439 cm ³
Drive:	Hydrostatic
Cutting height adjustment:	5 positions
Model no.:	13AB21HD603
Price:	-



LR2 NS76	
Cutting width:	76 cm
Lawn area (rec.):	3.000 m ² /h
Collecting volume:	Optional 115 l
Engine:	Cub Cadet OHV
Engine displacement:	439 cm ³
Drive:	Hydrostatic
Cutting height adjustment:	5 positions
Model no.:	13AB21JD603
Price:	-



LR2 ES76	
Cutting width:	76 cm
Lawn area (rec.):	3.000 m ² /h
Collecting volume:	Optional 115 l
Engine:	Cub Cadet 56 V / 30 Ah / 1.500 Wh
Output Watts:	3,0 kW
Drive:	Electric drive
Cutting height adjustment:	5 positions
Model no.:	33BA27JD603
Price:	-

MOWING TIME 60 MIN*
4 HOURS CHARGING TIME

*Deviations are possible depending on lawn area



INTELLIGENT PARKING ASSISTANCE (IPA)

The brand new IPA system makes parking your LR2 in your garage or summer house a breeze. The intelligent system halves the speed of your MINI-RIDER, for reversing more safely and precisely.

REVTEK™ TECHNOLOGY

RevTEK™ – The Reverse Mowing Technology allows you to continue mowing while backing up your MINI-RIDER. As a safety precaution this function must be activated manually. Always make sure that no children or animals are near the mowing area!



LIGHTS

LED lights for safer operation at dawn (except the LR1 MR76 and LR1 MS76).



ERGONOMIC STEERING

The ergonomic steering wheel provides maximum comfort in every situation and even after long working hours.



HYDROSTATIC DRIVE SYSTEM

The LR2 comes complete with a top-quality hydrostatic drive system. With the parking brake on the left and a one-pedal foot control on the right.



COMFORTABLE

Professional seat and steering column for working comfortably.



FRONT BUMPER

Prevent any damage to your MINI-RIDER.



SUPER GRIP PEDALS

Under challenging conditions, the super grip pedals provide maximum grip for safe driving.

MINI-RIDER ACCESSORIES

MULCH KIT/DEFLECTOR			
	Mulch Kit/deflector with blade for 76 cm decks	4 008423 862829	Mod. no.: 196-334-600 Price: -
	Mulch Kit/deflector incl. blade for 60 cm decks	4 008423 811797	Mod. no.: 196-707-678 Price: -
TWIN BAGGER			
	115 litres, for 76 cm decks	0 043033 563029	Mod. no.: 19A30014OEM Price: -
REAR HITCH			
	Rear hitch for LR series with side discharge	4 008423 914719	Mod. no.: 196-397-000 Price: -
	Rear hitch for LR series with rear discharge	4 008423 914726	Mod. no.: 196-398-000 Price: -

LR2

FORCE SERIES

LR1 MR76

LR1 MS76

ENGINE		
Engine type	Cub Cadet OHV	Cub Cadet OHV
Engine displacement	382 cm ³	382 cm ³
Rated power	7,4 kW / 2.700 min ⁻¹	7,9 kW / 2.900 min ⁻¹
Cylinders	Single	Single
Tank volume (capacity)	4,9 l	4,9 l
Lubrication	Fully pressurized automotive-style oil pump with spin-on oil filter	Fully pressurized automotive-style oil pump with spin-on oil filter
DRIVE SYSTEM		
Transmission	Transmatic	Transmatic
Speeds	6 (f/r), shift-on-the-go	6 (f/r), shift-on-the-go
Control	Foot pedal control with lever for manual pre-selection	Foot pedal control with lever for manual pre-selection
CUTTING SYSTEM		
Lawn area (rec./up to)	2.500 m ² /h	3.000 m ² /h
Cutting width	76 cm	76 cm
Cutting height (min-max)	38-95 mm	38-95 mm
Cutting options	3-in-1 option	2-in-1-option
Number of blades	1	1
Deck engagement	Manual lever control	Manual lever control
Deck height positions	5 positions	5 positions
Wash nozzle/Mulch Kit	Standard/Optional	Standard/Optional
DISCHARGE SYSTEM		
Bag (capacity)/accessory no.	Standard 200 l/-	Optional 115 l/(19A30014OEM)
Bag lever/Hardtop	2 grips/Hardtop	-/-
Bag fill indicator/grass deflector	Standard/Optional	-/Standard
FRAME		
Front axle	Steel	Steel
Front bumper	Standard	Standard
Turning radius	46 cm	46 cm
Wheel size (f/r in inch)	13 x 5 / 16 x 6,5	13 x 5 / 16 x 6,5
Wheel bearings	Sleeve bearings	Sleeve bearings
Frame	Easy entry frame	Easy entry frame
WHEELS		
Battery	12V, 135CCA, AGM	12V, 135CCA, AGM
Headlights	-	-
COMFORT		
Seat type	Comfort Seat	Comfort Seat
Seat adjustment	Tool-less	Tool-less
Steering wheel	Standard	Standard
Mow in reverse (RevTEK™)	Standard	Standard
Battery charger	(196-967-678)	(196-967-678)
DIMENSIONS		
LpA/LwA/LwAg (dB)	88/98/100	88/98/100
Vibration value body/K-factor	1,0 / 0,5 m/s ²	1,0 / 0,5 m/s ²
Vibration value hand/arm / K-factor	5,0 / 1,5 m/s ²	5,0 / 1,5 m/s ²
Dimensions (L/W/H)	225 cm / 86 cm / 112 cm	157 cm / 85 cm / 112 cm
Net weight	145 kg	127 kg
PRICE		
Model number	13B726HD603	13B726JD603
EAN	 4 008423 892284	 4 008423 892154
Price	-	-

LR2 NR76

LR2 NS76

LR2 ES76

ENGINE			
Engine type	Cub Cadet OHV	Cub Cadet OHV	Cub Cadet 56 V / 30 Ah / 1.500 Wh
Engine displacement	439 cm ³	439 cm ³	-
Rated power	8,1 kW / 2.700 min ⁻¹	8,6 kW / 2.950 min ⁻¹	3,0 kW / 2.083 min ⁻¹
Cylinders	Single	Single	-
Tank volume (capacity)	4,9 l	4,9 l	-
Lubrication	Fully pressurized automotive-style oil pump with spin-on oil filter	Fully pressurized automotive-style oil pump with spin-on oil filter	-
DRIVE SYSTEM			
Transmission	Hydrostatic	Hydrostatic	Electric drive
Speeds	Stepless	Stepless	Variable
Control	Foot pedal control	Foot pedal control	Foot pedal control
CUTTING SYSTEM			
Lawn area (rec./up to)	2.500 m ² /h	3.000 m ² /h	3.000 m ² /h
Cutting width	76 cm	76 cm	76 cm
Cutting height (min-max)	38-95 mm	38-95 mm	38-95 mm
Cutting options	3-in-1 option	2-in-1 option	2-in-1 option
Number of blades	1	1	1
Deck engagement	Manual lever control	Manual lever control	Electric PTO
Deck height positions	5 positions	5 positions	5 positions
Wash nozzle/Mulch Kit	Standard/Optional	Standard/Optional	-/Optional
DISCHARGE SYSTEM			
Bag (capacity)/accessory no.	Standard 200 l/-	Optional 115 l/(19A30014OEM)	Optional 115 l/(19A30014OEM)
Bag lever/Hardtop	2 grips/Hardtop	-/-	-/-
Bag fill indicator/grass deflector	Standard/Optional	-/Standard	-/Standard
FRAME			
Front axle	Steel	Steel	Steel
Front bumper	Standard	Standard	Standard, blue
Turning radius	46 cm	46 cm	46 cm
Wheel size (f/r in inch)	13 x 5 / 16 x 6,5	13 x 5 / 16 x 6,5	13 x 5 / 16 x 6,5
Wheel bearings	Sleeve bearings	Sleeve bearings	Sleeve bearings
Frame	Easy entry frame	Easy entry frame	Easy entry frame
WHEELS			
Battery	12V, 135CCA, AGM	12V, 135CCA, AGM	-
Headlights	LED	LED	LED
COMFORT			
Seat type	Deluxe High Comfort Seat	Deluxe High Comfort Seat	Cut & Sew, high back rest
Seat adjustment	Tool-less	Tool-less	Tool-less
Steering wheel	Standard	Standard	Standard
Mow in reverse (RevTEK™)	Standard	Standard	Standard
Battery charger	(196-967-678)	(196-967-678)	-
DIMENSIONS			
LpA/LwA/LwAg (dB)	88/98/100	88/98/100	n.a./n.a./n.a.
Vibration value body/K-factor	1,0 / 0,5 m/s ²	1,0 / 0,5 m/s ²	1,0 / 0,5 m/s ²
Vibration value hand/arm / K-factor	5,0 / 1,5 m/s ²	5,0 / 1,5 m/s ²	5,0 / 1,5 m/s ²
Dimensions (L/W/H)	225 cm / 86 cm / 112 cm	157 cm / 85 cm / 112 cm	170 cm / 97 cm / 88 cm
Net weight	172 kg	127 kg	163 kg
PRICE			
Model number	13AB21HD603	13AB21JD603	33BA27JD603
EAN	 4 008423 916041	 4 008423 916058	 4 008423 914856
Price	-	-	-

LT1 FORCE SERIES

COMFORTABLE SEAT WITH HIGH BACKREST FOR ALL LT MODELS

Mow frequently? For many hours? Then you know how important it is to sit comfortably. The high backrest supports an upright posture, making it far more comfortable.



COMFORT STEERING WHEEL

A 3-spoke soft grip steering wheel is standard on all LT2 and LT3 tractors.

CUTTING HEIGHT ADJUSTMENT

5-position height adjustment to easily change the cutting height (30–95 mm).



CENTRAL REAR DISCHARGE

All our rear discharge tractors are designed to transport grass clippings into the grass catcher with optimal efficiency. All LT Series rear discharge models feature a grass catcher made of durable fabric for flexibility and have an air passage to guarantee air flow and perfect collection. The hard top controls dust and reduces noise. The telescopic handle allows you to empty the grass catcher right from the driver's seat.

ENJOYABLE EXPERIENCE

Cub Cadet LT Series lawn tractors are extraordinarily versatile. They excel when it comes to covering large areas quickly thanks to the oversized grass catcher – and even more with side discharge, eliminating the need to stop and empty the catcher. Thanks to the user-friendly cutting height adjustment, the LT Series achieves optimum cutting results – even on difficult ground.



STEEL FRAME

All tractor frames are made of fully welded and powder-coated rugged steel.



FLOATING STEEL OR CAST IRON FRONT AXLE

Keeping all four wheels on the ground, however uneven the surface.



PIVOTING ONE-PIECE HOOD

The entire engine hood can be folded up within seconds without tools, for easy maintenance.



TRANSMATIC TRANSMISSION

Allows shift-on-the-go speed control. Simply choose the driving direction, set the desired basic speed with the speed shift lever on the dashboard and release the brake/clutch pedal. Push the pedal to slow down or press it all the way forward to stop. Releasing the brake pedal automatically brings the tractor back to a preset speed.



LT1 NR92

Cutting width:	92 cm
Area performance (rec.):	3.500 m ² /h
Collecting volume:	240 l
Engine:	Cub Cadet OHV
Engine displacement:	439 cm ³
Drive:	Transmatic
Cutting height adjustment:	5 positions
Model no.:	13AB77DE603
Price:	-



LT1 NS96

Cutting width:	96 cm
Area performance (rec.):	4.000 m ² /h
Collecting volume:	Optional 200 l
Engine:	Cub Cadet OHV
Engine displacement:	439 cm ³
Drive:	Transmatic
Cutting height adjustment:	5 positions
Model no.:	13AB77DF603
Price:	-

LT2
FORCE SERIES

LT3
FORCE SERIES



Our LT lawn tractors are equipped with a powerful and reliable Cub Cadet engine – developed in the USA.



HYDROSTATIC TRANSMISSION

Impresses with its modern technology. It features a self-lubricating hydro pump for minimum maintenance and maximum durability. The hydrostatic transmission also stands out for its velocity control as well as continual forward and reverse speeds. No clutching or shifting required. You can drive with millimeter accuracy, and very gently. The XT Series lawn tractors are foot-pedal controlled. The LT Series tractors are controlled by either a hand lever (side discharger tractors) or a foot pedal (rear discharger tractors).

COMFORT STEERING WHEEL:
A 3-spoke soft grip steering wheel is standard on all LT2 and LT3 tractors.

REVTEK™ TECHNOLOGY
Reserve mowing technology. Allows you to cut while in reverse. Available with LT3 PR105 & LT3 PS107.

COMFORTABLE SEAT WITH HIGH BACKREST FOR ALL LT MODELS



LT2 NR92

Cutting width:	92 cm
Lawn area (rec.):	3.500 m ² /h
Collecting volume:	240 l
Engine:	Cub Cadet OHV
Engine displacement:	439 cm ³
Drive:	Hand-hydrostatic
Cutting height adjustment:	5 positions
Model no.:	13BB71DE603
Price:	-



LT2 NS96

Cutting width:	96 cm
Lawn area (rec.):	4.000 m ² /h
Collecting volume:	Optional 200 l
Engine:	Cub Cadet OHV
Engine displacement:	439 cm ³
Drive:	Hand-hydrostatic
Cutting height adjustment:	5 positions
Model no.:	13BB79DF603
Price:	-



LT3 PR105

Cutting width:	105 cm
Lawn area (rec.):	4.500 m ² /h
Collecting volume:	240 l
Engine:	Cub Cadet OHV, V-TWIN dual cylinder
Engine displacement:	679 cm ³
Drive:	Hydrostatic
Cutting height adjustment:	5 positions
Model no.:	13BJ71DN603
Price:	-



LT3 PS107

Cutting width:	107 cm
Lawn area (rec.):	5.500 m ² /h
Collecting volume:	Optional 200 l
Engine:	Cub Cadet OHV, V-TWIN dual cylinder
Engine displacement:	679 cm ³
Drive:	Hydrostatic
Cutting height adjustment:	5 positions
Model no.:	13BJ79DG603
Price:	-

	LT1 NR92	LT1 NS96	LT2 NR92
ENGINE			
Engine type	Cub Cadet OHV	Cub Cadet OHV	Cub Cadet OHV
Engine displacement	439 cm ³	439 cm ³	439 cm ³
Rated power	8,1 kW / 2.700 min ⁻¹	8,3 kW / 2.800 min ⁻¹	8,1 kW / 2.700 min ⁻¹
Cylinders	Single	Single	Single
Tank volume (capacity)	3,8 l	3,8 l	3,8 l
DRIVE SYSTEM			
Transmission	Transmatic	Transmatic	Hand-hydrostatic
Speeds	6 (f/r), shift-on-the-go	6 (f/r), shift-on-the-go	Infinitely variable (f/r)
Control	Foot pedal control with lever for manual pre-selection	Foot pedal control with lever for manual pre-selection	Foot pedal control
Cruise control	-	-	-
CUTTING SYSTEM			
Lawn area (rec./up to)	3.500 m ² /h	4.000 m ² /h	3.500 m ² /h
Cutting width	92 cm	96 cm	92 cm
Cutting height (min-max)	30-95 mm	30-95 mm	30-95 mm
Number of blades	2	2	2
Deck engagement	Manual lever control	Manual lever control	Manual lever control
Deck height positions	5 positions	5 positions	5 positions
Deck wheels	-	-	-
Wash nozzle/Mulch Kit	-(196-749A678)	-/optional (OEM-190A116)	-/optional (196-749A678)
DISCHARGE SYSTEM			
Bag (capacity)/accessory no.	240 l/-	Optional 200 l/(OEM-190-180A)	240 l/-
Bag lever/hardtop	Telescopic handle/PVC hardtop	-/-	Telescopic handle/PVC hardtop
Bag fill indicator/grass deflector	-(196-750A678)	-/Standard	-/optional (196-750A678)
FRAME			
Front axle	Steel	Steel	Steel
Front bumper	optional (OEM-190-679)	optional (OEM-190-679)	optional (OEM-190-679)
Turning radius	46 cm	46 cm	46 cm
Wheel size (f/r in inch)	15 x 6 / 18 x 9,5	15 x 6 / 20 x 8	15 x 6 / 18 x 9,5
Wheel bearings	Sleeve bearings	Sleeve bearings	Sleeve bearings
Frame	Easy entry frame	Easy entry frame	Easy entry frame
Headlights	Standard	Standard	Standard
COMFORT			
Seat type	Comfort, high back	Comfort, high back	Comfort, high back
Seat adjustment	Tool-less	Tool-less	Tool-less
Steering wheel	Standard	Standard	Soft-Grip
Toolbox/Cupholder	-/-	-/-	-/-
Mow in reverse (RevTEK™)	-	-	-
Battery charger	optional (196-967-678)	optional (196-967-678)	optional (196-967-678)
DIMENSIONS			
LpA/LwA/LwAg (dB)	88/98/100	88/98/100	88/98/100
Vibration value body/K-factor	1,0 / 0,5 m/s ²	1,0 / 0,5 m/s ²	1,0 / 0,5 m/s ²
Vibration value hand/arm / K-factor	5,0 / 1,5 m/s ²	5,0 / 1,5 m/s ²	5,0 / 1,5 m/s ²
Dimensions (L/W/H)	225 cm / 99 cm / 103 cm	170 cm / 107 cm / 100 cm	225 cm / 99 cm / 103 cm
Net weight	195 kg	150 kg	195 kg
PRICE			
Model number	13AB77DE603	13AB77DF603	13BB71DE603
EAN	4 008423 891829	4 008423 891836	4 008423 891812
Price	-	-	-

	LT2 NS96	LT3 PR105	LT3 PS107
ENGINE			
Engine type	Cub Cadet OHV	Cub Cadet OHV	Cub Cadet OHV
Engine displacement	439 cm ³	679 cm ³	679 cm ³
Rated power	8,3 kW / 2.800 min ⁻¹	12,7 kW / 2.700 min ⁻¹	12,3 kW / 2.600 min ⁻¹
Cylinders	Single	V-TWIN dual cylinder	V-TWIN dual cylinder
Tank volume (capacity)	3,8 l	3,8 l	3,8 l
DRIVE SYSTEM			
Transmission	Hand-hydrostatic	Hydrostatic	Hydrostatic
Speeds	Infinitely variable (f/r)	Infinitely variable (f/r)	Infinitely variable (f/r)
Control	Manual lever control	Foot pedal control	Manual lever control
Cruise control	-	-	-
CUTTING SYSTEM			
Lawn area (rec./up to)	4.000 m ² /h	4.500 m ² /h	5.500 m ² /h
Cutting width	96 cm	105 cm	107 cm
Cutting height (min-max)	30-95 mm	30-95 mm	30-95 mm
Number of blades	2	2	2
Deck engagement	Manual lever control	Manual lever control	Manual lever control
Deck height positions	5 positions	5 positions	5 positions
Deck wheels	-	2	2
Wash nozzle/Mulch Kit	-/optional (OEM-190A116)	Standard/optional (196-749A678)	Standard/Standard
DISCHARGE SYSTEM			
Bag (capacity)/accessory no.	Optional 200 l/optional (OEM-190-180A)	240 l/-	Optional 200 l/optional (OEM-190-180A)
Bag lever/hardtop	-/-	Telescopic handle/PVC hardtop	-/-
Bag fill indicator/grass deflector	-/Standard	-/optional (196-750A678)	-/Standard
FRAME			
Front axle	steel	Heavy-duty cast-iron	Heavy-duty cast-iron
Front bumper	optional (OEM-190-679)	Standard	Standard
Turning radius	46 cm	46 cm	46 cm
Wheel size (f/r in inch)	15 x 6 / 20 x 8	15 x 6 / 18 x 9,5	15 x 6 / 20 x 8
Wheel bearings	Sleeve bearings	Sleeve bearings	Sleeve bearings
Frame	Easy entry frame	Easy entry frame	Easy entry frame
Headlights	Standard	Standard	Standard
COMFORT			
Seat type	Comfort, high back	Comfort, high back	Comfort, high back
Seat adjustment	Tool-less	Tool-less	Tool-less
Steering wheel	Soft-Grip	Soft-Grip	Soft-Grip
Toolbox/Cupholder	-/-	-/-	-/-
Mow in reverse (RevTEK™)	-	Standard	Standard
Battery charger	optional (196-967-678)	optional (196-967-678)	optional (196-967-678)
DIMENSIONS			
LpA/LwA/LwAg (dB)	88/98/100	88/98/100	88/98/100
Vibration value body/K-factor	1,0 / 0,5 m/s ²	1,0 / 0,5 m/s ²	1,0 / 0,5 m/s ²
Vibration value hand/arm / K-factor	5,0 / 1,5 m/s ²	5,0 / 1,5 m/s ²	5,0 / 1,5 m/s ²
Dimensions (L/W/H)	170 cm / 107 cm / 100 cm	225 cm / 110 cm / 103 cm	170 cm / 115 cm / 100 cm
Net weight	150 kg	198 kg	175 kg
PRICE			
Model number	13BB79DF603	13BJ71DN603	13BJ79DG603
EAN	4 008423 891843	4 008423 899863	4 008423 899870
Price	-	-	-

THE TOP 5 OF THE FEATURES!

POWER LIKE NEVER BEFORE!



1. MARKET-LEADING CUTTING, COLLECTING & MULCHING SYSTEM

Optimize your mowing results in minimum time.



Learn more



2. THE SMALLEST TURNING RADIUS ON THE MARKET

Unbeatable efficiency even in confined spaces thanks to innovative TIGHT TURN Technology.



3. ULTRA-STURDY, CORROSIONRESISTANT FRAME

Ultra-rigid frame for top durability.



4. PERFECTLY MATCHED TRANSMISSION AND ENGINE POWER

Optimal drive power and the strongest engine in its class.



5. ULTRA-RELIABLE V-BELT DESIGN

Thanks to reduced fan belt tension and ingenious, perfect fan belt guidance without twisted fan belts, the Cub Cadet mowing deck operates with impressive stability and endurance. The XT2 QS117 and XT3 QS137 tractors are also equipped with a welded mowing deck, which is even sturdier and more durable.

THE XT ENDURO SERIES AT A GLANCE



- A MARKET-LEADING CUTTING, COLLECTING AND MULCHING SYSTEM**
- Thanks to the all-new grass cuttings transport system and the rear-discharge mowing decks.
 - With twice the grass-catching of previous Cub Cadet lawn tractors.
 - Best side discharge grass catcher on the market.
 - Push-button switch-on.

320 LITRE GRASS CATCHER

360 LITRE GRASS CATCHER

HYDROSTATIC V-BELT

HYDROSTATIC POWER TRANSMISSION
Jerk-free drive system – simply press the pedal and drive

POWERFUL CUB CADET ENGINE
high performance and reliable – developed in the USA
(XT1 OS96, XT1 OS107, XT1 OR95, XT1 OR106)

EFFICIENT CUB CADET V-TWIN ENGINE
2-cylinder engine produced in house
(XT2 PR106, XT2 PS 117)

KAWASAKI V-TWIN ENGINE
(XT2 PR95, XT2 QR106, XT2 PS107, XT2 QS117)

KAWASAKI V-TWIN ENGINE
2-cylinder engine for difficult terrain, ultra-smooth running and low fuel consumption (XT3 QS127, XT3 QS137, XT3 QR106)

EASIEST STEERING SYSTEM ON THE MARKET

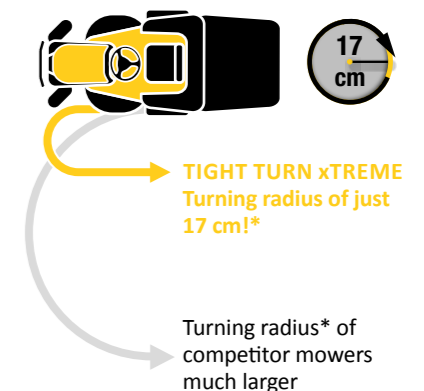
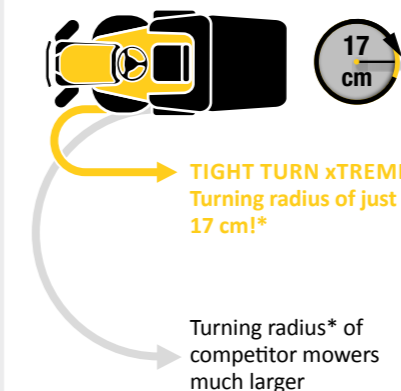
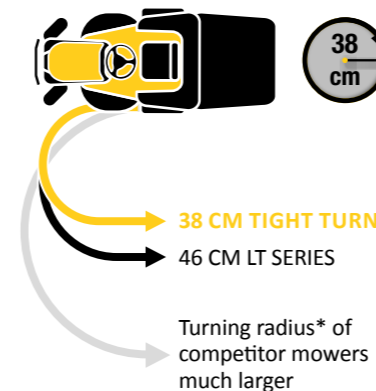

ELECTRIC BAG LIFT available as accessory for all rear discharge models from 2018 onwards

SOLID, WELDED MOWING DECK for XT2 QS117 & XT3 QS137

12V MULTI-FUNCTION CHARGING SOCKET FOR THE REAR DISCHARGE MODELS

ANTI-DUST GRASS CATCHER SYSTEM
AVAILABLE AS AN OPTIONAL EXTRA

ANTI-DUST GRASS CATCHER SYSTEM
AVAILABLE AS AN OPTIONAL EXTRA

ANTI-DUST SYSTEM
Rear discharge with multi-layer dust apron included in accessories. The apron protects against flying grass and dirt

ALL-GROUND TRACTION SYSTEM
Perfect traction even on heavy ground – thanks to mechanical differential lock

*The turning radius of a lawn tractor involves marking the position of the left rear wheel while the tractor completes a 360-degree circle (on plain ground). Now you measure the distance between the mark and the actual position of the left rear wheel again. Half this distance is the turning radius – included in all product specifications.

XT1™ ENDURO SERIES™

Cub Cadet ENGINES

Selected XT lawn tractors are equipped with a powerful and reliable Cub Cadet engine – developed in the USA.



Learn more

UNBELIEVABLE POWER AND EFFICIENCY

The Cub Cadet XT series, part of the latest generation of garden tractors, sets new standards for power, performance and robust quality – offering you the ultimate power package. XT1 lawn tractors are ideally equipped for mowing, collecting and transporting clippings and can also be expanded with a special range of accessories.



DIAGONAL ADJUSTABLE SEAT
Individually adaptable – pure comfort for all users.



PUSH BUTTON BLADE START
Use the drive only when in use – that's more efficient and safer.



MECHANICALLY SUPPORTED CUTTING HEIGHT ADJUSTMENT
Quickly and easily select the perfect setting.



HYDROSTATIC POWER TRANSMISSION
Jerk-free, smooth starting for precise mowing.



XT1 OS96

Cutting width:	96 cm
Lawn area (rec.):	6.000 m ² /h
Collecting volume:	Optional 200 l
Engine:	Cub Cadet
Engine displacement:	547 cm ³
Drive:	Hydrostatic
Cutting height adjustment:	12 positions
Model no.:	13A8A1TF603
Price:	-



XT1 OS107

Cutting width:	107 cm
Lawn area (rec.):	8.000 m ² /h
Collecting volume:	Optional 200 l
Engine:	Cub Cadet
Engine displacement:	547 cm ³
Drive:	Hydrostatic
Cutting height adjustment:	12 positions
Model no.:	13A8A1TS603
Price:	-



XT1 OR95

Cutting width:	95 cm
Lawn area (rec.):	5.500 m ² /h
Collecting volume:	320 l
Engine:	Cub Cadet
Engine displacement:	547 cm ³
Drive:	Hydrostatic
Cutting height adjustment:	12 positions
Model no.:	13A8A1TB603
Price:	-



XT1 OR106

Cutting width:	106 cm
Lawn area (rec.):	7.500 m ² /h
Collecting volume:	320 l
Engine:	Cub Cadet
Engine displacement:	547 cm ³
Drive:	Hydrostatic
Cutting height adjustment:	12 positions
Model no.:	13A8A1TR603
Price:	-

Cub Cadet TIGHT TURN XTREME

Just 17 cm turning radius thanks to TIGHT TURN XTREME.



POWERFUL TWO-CYLINDER ENGINES
All petrol-powered XT2 models are equipped with efficient Cub Cadet, or Kawasaki two-cylinder engines.



GRASS CATCHER WITH ELECTRIC BAG LIFT
One touch of a button – and the grass bag is lifting up. Can be retrofitted to all XT rear discharge models from 2018 onwards.

POWER FOR GREATER CHALLENGES

The Cub Cadet XT2 offers you an even higher level of power, control functions and durability. XT2 lawn tractors are ideal for working on tough terrain, transporting and using additional accessories, whatever the season.



XT2 PR95

Cutting width:	95 cm
Lawn area (rec.):	6.000 m ² /h
Collecting volume:	320 l
Engine:	Kawasaki, V-TWIN dual cylinder
Engine displacement:	603 cm ³
Drive:	Hydrostatic
Cutting height adjustment:	12 positions
Model no.:	13AGA1TB603
Price:	-



XT2 PR106

Cutting width:	106 cm
Lawn area (rec.):	8.000 m ² /h
Collecting volume:	320
Engine:	Cub Cadet, V-TWIN dual cylinder
Engine displacement:	679 cm ³
Drive:	Hydrostatic
Cutting height adjustment:	12 positions
Model no.:	13AJA1TR603
Price:	-



XT2 QR106

Cutting width:	106 cm
Lawn area (rec.):	8.000 m ² /h
Collecting volume:	320 l
Engine:	Kawasaki, V-TWIN dual cylinder
Engine displacement:	726 cm ³
Drive:	Hydrostatic
Cutting height adjustment:	12 positions
Model no.:	13AFA1TR603
Price:	-



XT2 ES107

Cutting width:	107 cm
Lawn area (rec.):	8.000 m ² /h
Collecting volume:	Optional 200 l
Engine:	Cub Cadet 56 V / 60 Ah / 3.000 Wh
Output Watts:	3,0 kW
Drive:	Electric drive
Cutting height adjustment:	12 positions
Model no.:	33ABA7ES603
Price:	-

NEW
Li-Ion ELECTRIC
MOWING TIME
90 MIN*
4 HOURS
CHARGING TIME

*Deviations are possible depending on lawn area
Image shows US model



XT2 PS107

Cutting width:	107 cm
Lawn area (rec.):	8.500 m ² /h
Collecting volume:	Optional 200 l
Engine:	Kawasaki, V-TWIN dual cylinder
Engine displacement:	603 cm ³
Drive:	Hydrostatic
Cutting height adjustment:	12 positions
Model no.:	13AGA1TS603
Price:	-



XT2 PS117

Cutting width:	117 cm
Lawn area (rec.):	9.000 m ² /h
Collecting volume:	Optional 200 l
Engine:	Cub Cadet, V-TWIN dual cylinder
Engine displacement:	679 cm ³
Drive:	Hydrostatic
Cutting height adjustment:	12 positions
Model no.:	13AJA1TT603
Price:	-



XT2 QS117

Cutting width:	117 cm, welded mowing deck
Lawn area (rec.):	9.000 m ² /h
Collecting volume:	Optional 200 l
Engine:	Kawasaki, V-TWIN dual cylinder
Engine displacement:	726 cm ³
Drive:	Hydrostatic
Cutting height adjustment:	12 positions
Model no.:	13AFA1TN603
Price:	-



MASSIVE, WELDED MOWING UNIT
For high durability and absolute robustness with the XT2 QS117.



Learn more



XT2™

ENDURO SERIES™

XT3™
ENDURO SERIES™

Cub Cadet
**TIGHT TURN
XTREME**



Just 17 cm turning radius thanks to TIGHT TURN XTREME.

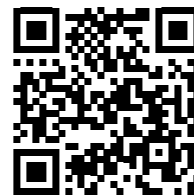

Learn more

Cub Cadet
**ALL-GROUND
TRACTION**

Optimum traction, however tough the terrain – thanks to the mechanical differential lock.

**MAXIMUM STRENGTH
AND POWER FOR THE
TOUGHEST TASK**

Designed to meet the toughest demands, driven by true power packages and equipped with ultra-strong components – the Cub Cadet XT3 are the ultimate lawn tractors. The XT3 have plenty of power to mow even high, thick grass to carry larger loads and for extra heavy tillage accessories.



LARGEST GRASS CATCHER ON THE MARKET
Vast 360 litre capacity ensures maximum efficiency.



STRONG V-TWIN KAWASAKI ENGINE
Two-cylinder engine for demanding terrain with particularly quiet running and low fuel consumption.



ANTI-DUST SYSTEM
Rear discharge with multi-layer dust apron included in the equipment, protects against swirling grass and dirt.



MASSIVE, WELDED MOWING UNIT
For high durability and absolute robustness with the XT3 QS137.



XT3 QR106

Cutting width:	106 cm
Lawn area (rec.):	8.000 m ² /h
Collecting volume:	360 l, with Anti dust system
Engine:	Kawasaki, V-TWIN dual cylinder
Engine displacement:	726 cm ³
Drive:	Hydrostatic, All-Ground Traction System
Cutting height adjustment:	12 positions
Model no.:	13AFASTR603
Price:	-



XT3 QS127

Cutting width:	127 cm
Lawn area (rec.):	10.000 m ² /h
Collecting volume:	Optional 210 l
Engine:	Kawasaki, V-TWIN dual cylinder
Engine displacement:	726 cm ³
Drive:	Hydrostatic, All-Ground Traction System
Cutting height adjustment:	12 positions
Model no.:	14AFASTQ603
Price:	-



XT3 QS137

Cutting width:	137 cm, welded mowing deck
Lawn area (rec.):	11.000 m ² /h
Collecting volume:	Optional 210 l
Engine:	Kawasaki, V-TWIN dual cylinder
Engine displacement:	726 cm ³
Drive:	Hydrostatic, All-Ground Traction System
Cutting height adjustment:	12 positions
Model no.:	14AFASTM603
Price:	-

XT1 OS96

XT1 OS107

ENGINE		
Engine type	Cub Cadet	Cub Cadet
Engine displacement	547 cm ³	547 cm ³
Rated power	9,0 kW / 2.300 min ⁻¹	6,6 kW / 2.250 min ⁻¹
Cylinders	Single	Single
Tank volume (capacity)	11,4 l	11,4 l
DRIVE SYSTEM		
Transmission	Hydrostatic	Hydrostatic
Speeds	Infinitely variable (f/r)	Infinitely variable (f/r)
Control	Foot pedal control	Foot pedal control
Cruise control	Standard	Standard
CUTTING SYSTEM		
Lawn area (rec./up to)	6.000 m ² /h	8.000 m ² /h
Cutting width	96 cm	107 cm
Cutting height (min-max)	25–100 mm	25–100 mm
Cutting deck	stamped	stamped
Number of blades	2	2
Deck engagement	Electric PTO	Electric PTO
Deck height positions	12 positions	12 positions
Deck wheels	2 balls deck wheels	2 balls deck wheels
Wash nozzle/Mulch Kit/mulching blades	–/Standard/Standard	Standard/Standard/Standard
DISCHARGE SYSTEM		
Bag (capacity)/accessory no.	Optional 200 l/(OEMR190-180A)	Optional 200 l/(19A30030100)
Bag lever/hardtop	–/–	–/–
Bag fill indicator/grass deflector	–/Standard	–/Standard
FRAME		
Front axle	Heavy-duty cast-iron	Heavy-duty cast-iron
Front bumper	Standard	Standard
Turning radius	TIGHT TURN 38 cm	TIGHT TURN 38 cm
Wheel size (f/r in inch)	15 x 6 Turf Saver / 20 x 8	15 x 6 Turf Saver / 20 x 8
Wheel bearings	Sleeve bearings	Sleeve bearings
Frame	Fully robotically-welded frame	Fully robotically-welded frame
ELECTRIC		
Headlights	LED	LED
COMFORT		
Seat type	Cut & Sew, high back rest	Cut & Sew, high back rest
Seat adjustment	Lever, angled, 10 slide	Lever, angled, 10 slide
Steering wheel	Ergonomic with gentle touch	Ergonomic with gentle touch
Toolbox/Cupholder	Standard/Standard	Standard/Standard
Mow in reverse (RevTEK™)	Standard	Standard
DIMENSIONS		
LpA/LwA/LwAg (dB)	88/98/100	88/98/100
Vibration value body / K-factor	1,0 / 0,5 m/s ²	1,0 / 0,5 m/s ²
Vibration value hand/arm / K-factor	5,0 / 1,5 m/s ²	5,0 / 1,5 m/s ²
Dimensions (L/W/H)	175 cm / 124 cm / 110 cm	175 cm / 134 cm / 110 cm
Net weight	195 kg	195 kg
PRICE		
Model number	13A8A1TF603	13A8A1TS603
EAN	 4 008423 872224	 4 008423 872248
Price	-	-

XT1 OR95

XT1 OR106

ENGINE		
Engine type	Cub Cadet	Cub Cadet
Engine displacement	547 cm ³	547 cm ³
Rated power	6,2 kW / 2.100 min ⁻¹	6,6 kW / 2.250 min ⁻¹
Cylinders	Single	Single
Tank volume (capacity)	11,4 l	11,4 l
DRIVE SYSTEM		
Transmission	Hydrostatic	Hydrostatic
Speeds	Infinitely variable (f/r)	Infinitely variable (f/r)
Control	Foot pedal control	Foot pedal control
Cruise control	Standard	Standard
CUTTING SYSTEM		
Lawn area (rec./up to)	5.500 m ² /h	7.500 m ² /h
Cutting width	95 cm	106 cm
Cutting height (min-max)	25–100 mm	25–100 mm
Cutting deck	stamped	stamped
Number of blades	2	2
Deck engagement	Electric PTO	Electric PTO
Deck height positions	12 positions	12 positions
Deck wheels	2 balls deck wheels	4 balls deck wheels
Wash nozzle/Mulch Kit/mulching blades	Standard/(196-551-000)/(196-561-000)	Standard/(196-550-000)/(196-560-000)
DISCHARGE SYSTEM		
Bag (capacity)/accessory no.	320 l/(196-555-603 Anti-Dust-System)	320 l/(196-555-603 Anti-Dust-System)
Bag lever/hardtop	Rounded ergo telescopic handle/Plastic	Rounded ergo telescopic handle/Plastic
Bag fill indicator/grass deflector	Deluxe w Blade Shutoff/(196-552A000)	Deluxe w Blade Shutoff/(196-552A000)
FRAME		
Front axle	Heavy-duty cast-iron	Heavy-duty cast-iron
Front bumper	Standard	Standard
Turning radius	TIGHT TURN 38 cm	TIGHT TURN 38 cm
Wheel size (f/r in inch)	15 x 6 Turf Saver / 18 x 8,5	15 x 6 Turf Saver / 18 x 8,5
Wheel bearings	Sleeve bearings	Sleeve bearings
Frame	Fully robotically-welded frame	Fully robotically-welded frame
ELECTRIC		
Headlights	LED	LED
COMFORT		
Seat type	Cut & Sew, high back rest	Cut & Sew, high back rest
Seat adjustment	Lever, angled, 10 slide	Lever, angled, 10 slide
Steering wheel	Ergonomic with gentle touch	Ergonomic with gentle touch
Toolbox/Cupholder	Standard/Standard	Standard/Standard
Mow in reverse (RevTEK™)	Standard	Standard
DIMENSIONS		
LpA/LwA/LwAg (dB)	88/98/100	88/98/100
Vibration value body / K-factor	1,0 / 0,5 m/s ²	1,0 / 0,5 m/s ²
Vibration value hand/arm / K-factor	5,0 / 1,5 m/s ²	5,0 / 1,5 m/s ²
Dimensions (L/W/H)	245 cm / 100 cm / 118 cm	245 cm / 110 cm / 118 cm
Net weight	235 kg	258 kg
PRICE		
Model number	13A8A1TB603	13A8A1TR603
EAN	 4 008423 872217	 4 008423 872231
Price	-	-

XT2 PR95

XT2 PR106

ENGINE		
Engine type	Kawasaki	Cub Cadet
Engine displacement	603 cm ³	679 cm ³
Rated power	9,3 kW / 2.150 min ⁻¹	14,9 kW / 2.150 min ⁻¹
Cylinders	V-TWIN dual cylinder	V-TWIN dual cylinder
Tank volume (capacity)	11,4 l	11,4 l
DRIVE SYSTEM		
Transmission	Hydrostatic	Hydrostatic
Speeds	Infinitely variable (f/r)	Infinitely variable (f/r)
Control	Foot pedal control	Foot pedal control
Cruise control	Standard	Standard
CUTTING SYSTEM		
Lawn area (rec./up to)	6.000 m ² /h	8.000 m ² /h
Cutting width	95 cm	106 cm
Cutting height (min-max)	25–100 mm	25–100 mm
Cutting deck	stamped	stamped
Number of blades	2	2
Deck engagement	Electric PTO	Electric PTO
Deck height positions	12 positions	12 positions
Deck wheels	2 balls deck wheels	4 balls deck wheels
Wash nozzle/Mulch Kit/mulching blades	Standard/(196-551-000)/(196-561-000)	Standard/(196-550-000)/(196-560-000)
DISCHARGE SYSTEM		
Bag (capacity)/accessory no.	320 l/(196-555-603 Anti-Dust-System)	320 l/(Anti-Dust-system 196-553-603)
Bag lever/hardtop	Rounded ergo telescopic handle/Plastic	Rounded ergo telescopic handle/Plastic
Bag fill indicator/grass deflector	Deluxe w Blade Shutoff/(196-552A000)	Deluxe w Blade Shutoff/(196-552A000)
FRAME		
Front axle	Heavy-duty cast-iron	Heavy-duty cast-iron
Front bumper	Standard, yellow	Standard, yellow
Turning radius	TIGHT TURN xTREME 17 cm	TIGHT TURN xTREME 17 cm
Wheel size (f/r in inch)	15 x 6 Turf Saver / 18 x 8,5	15 x 6 Turf Saver / 18 x 8,5
Wheel bearings	Sleeve bearings	Sleeve bearings
Frame	Fully robotically-welded frame	Fully robotically-welded frame
ELECTRIC		
Headlights	LED	LED
COMFORT		
Seat type	Cut & Sew, high back rest	Cut & Sew, high back rest
Seat adjustment	Lever, angled, 10 slide	Lever, angled, 10 slide
Steering wheel	Ergonomic with gentle touch	Ergonomic with gentle touch
Toolbox/Cupholder	Standard/Standard	Standard/Standard
Mow in reverse (RevTEK™)	Standard	Standard
DIMENSIONS		
LpA/LwA/LwAg (dB)	88/98/100	n.a./n.a./n.a.
Vibration value body / K-factor	1,0 / 0,5 m/s ²	1,0 / 0,5 m/s ²
Vibration value hand/arm / K-factor	5,0 / 1,5 m/s ²	5,0 / 1,5 m/s ²
Dimensions (L/W/H)	250 cm / 100 cm / 118 cm	250 cm / 110 cm / 118 cm
Net weight	254 kg	253 kg
PRICE		
Model number	13AGA1TB603	13AJA1TR603
EAN	 4 008423 872279	 4 008423 922554
Price	-	-

XT2 QR106

XT2 PS107

ENGINE		
Engine type	Kawasaki	Kawasaki
Engine displacement	726 cm ³	603 cm ³
Rated power	11,6 kW / 2.200 min ⁻¹	9,8 kW / 2.300 min ⁻¹
Cylinders	V-TWIN dual cylinder	V-TWIN dual cylinder
Tank volume (capacity)	11,4 l	11,4 l
DRIVE SYSTEM		
Transmission	Hydrostatic	Hydrostatic
Speeds	Infinitely variable (f/r)	Infinitely variable (f/r)
Control	Foot pedal control	Foot pedal control
Cruise control	Standard	Standard
CUTTING SYSTEM		
Lawn area (rec./up to)	8.000 m ² /h	8.500 m ² /h
Cutting width	106 cm	107 cm
Cutting height (min-max)	25–100 mm	25–100 mm
Cutting deck	stamped	stamped
Number of blades	2	2
Deck engagement	Electric PTO	Electric PTO
Deck height positions	12 positions	12 positions
Deck wheels	4 balls deck wheels	2 balls deck wheels
Wash nozzle/Mulch Kit/mulching blades	Standard/(196-550-000)/(196-560-000)	Standard/Standard/Standard
DISCHARGE SYSTEM		
Bag (capacity)/accessory no.	320 l/(196-555-603 Anti-Dust-System)	Optional 200 l/(19A30030100)
Bag lever/hardtop	Rounded ergo telescopic handle/Plastic	-/-
Bag fill indicator/grass deflector	Deluxe w Blade Shutoff/(196-552A000)	-/Standard
FRAME		
Front axle	Heavy-duty cast-iron	Heavy-duty cast-iron
Front bumper	Standard, yellow	Standard, yellow
Turning radius	TIGHT TURN xTREME 17 cm	TIGHT TURN xTREME 17 cm
Wheel size (f/r in inch)	15 x 6 Turf Saver / 18 x 8,5	15 x 6 Turf Saver / 20 x 8
Wheel bearings	Sleeve bearings	Sleeve bearings
Frame	Fully robotically-welded frame	Fully robotically-welded frame
ELECTRIC		
Headlights	LED	LED
COMFORT		
Seat type	Cut & Sew, high back rest	Cut & Sew, high back rest
Seat adjustment	Lever, angled, 10 slide	Lever, angled, 10 slide
Steering wheel	Ergonomic with gentle touch	Ergonomic with gentle touch
Toolbox/Cupholder	Standard/Standard	Standard/Standard
Mow in reverse (RevTEK™)	Standard	Standard
DIMENSIONS		
LpA/LwA/LwAg (dB)	88/98/100	88/98/100
Vibration value body / K-factor	1,0 / 0,5 m/s ²	1,0 / 0,5 m/s ²
Vibration value hand/arm / K-factor	5,0 / 1,5 m/s ²	5,0 / 1,5 m/s ²
Dimensions (L/W/H)	250 cm / 110 cm / 118 cm	180 cm / 134 cm / 100 cm
Net weight	253 kg	210 kg
PRICE		
Model number	13AFA1TR603	13AGA1TS603
EAN	 4 008423 872262	 4 008423 872286
Price	-	-

XT2 PS117

XT2 QS117

ENGINE		
Engine type	Cub Cadet	Kawasaki
Engine displacement	679 cm ³	726 cm ³
Rated power	14,9 kW / n.a. min ⁻¹	15,8 kW / n.a. min ⁻¹
Cylinders	V-TWIN dual cylinder	V-TWIN dual cylinder
Tank volume (capacity)	11,4 l	11,4 l
DRIVE SYSTEM		
Transmission	Hydrostatic	Hydrostatic
Speeds	Infinitely variable (f/r)	Infinitely variable (f/r)
Control	Foot pedal control	Foot pedal control
Cruise control	Standard	Standard
CUTTING SYSTEM		
Lawn area (rec./up to)	9.000 m ² /h	9.000 m ² /h
Cutting width	117 cm	117 cm
Cutting height (min-max)	25–100 mm	25–100 mm
Cutting deck	stamped	welded mowing deck
Number of blades	2	2
Deck engagement	Electric PTO	Electric PTO
Deck height positions	12 positions	12 positions
Deck wheels	4 balls deck wheels	4 balls deck wheels
Wash nozzle/Mulch Kit/mulching blades	Standard/Standard/Standard	Standard/Standard/Standard
DISCHARGE SYSTEM		
Bag (capacity)/accessory no.	Optional 200 l/(19A30030100)	Optional 200 l/(19A30030100)
Bag lever/hardtop	–/–	–/–
Bag fill indicator/grass deflector	–/Standard	–/Standard
FRAME		
Front axle	Heavy-duty cast-iron	Heavy-duty cast-iron
Front bumper	Standard, yellow	Standard, yellow
Turning radius	TIGHT TURN xTREME 17 cm	TIGHT TURN xTREME 17 cm
Wheel size (f/r in inch)	15 x 6 Turf Saver / 20 x 8,5	15 x 6 Turf Saver / 20 x 8,5
Wheel bearings	Sleeve bearings	Sleeve bearings
Frame	Fully robotically-welded frame	Fully robotically-welded frame
ELECTRIC		
Headlights	LED	LED
COMFORT		
Seat type	Cut & Sew, high back rest	Cut & Sew, high back rest
Seat adjustment	Lever, angled, 10 slide	Lever, angled, 10 slide
Steering wheel	Ergonomic with gentle touch	Ergonomic with gentle touch
Toolbox/Cupholder	Standard/Standard	Standard/Standard
Mow in reverse (RevTEK™)	Standard	Standard
DIMENSIONS		
LpA/LwA/LwAg (dB)	n.a./n.a./n.a.	n.a./n.a./n.a.
Vibration value body / K-factor	1,0 / 0,5 m/s ²	1,0 / 0,5 m/s ²
Vibration value hand/arm / K-factor	5,0 / 1,5 m/s ²	5,0 / 1,5 m/s ²
Dimensions (L/W/H)	180 cm / 146 cm / 110 cm	180 cm / 144 cm / 110 cm
Net weight	215 kg	230 kg
PRICE		
Model number	13AJA1TT603	13AFA1TN603
EAN		
Price	-	-

XT2 ES107

XT3 QR106

ENGINE		
Engine type	Cub Cadet 56 V / 60 Ah / 3.000 Wh	Kawasaki
Engine displacement	–	726 cm ³
Rated power	3,0 kW / 2.100 min ⁻¹	11,6 kW / 2.200 min ⁻¹
Cylinders	–	V-TWIN dual cylinder
Tank volume (capacity)	–	11,4 l
DRIVE SYSTEM		
Transmission	Electric drive	Hydrostatic, All-Ground Traction System
Speeds	Infinitely variable	Infinitely variable (f/r)
Control	Foot pedal control	Foot pedal control
Cruise control	Standard	Standard
CUTTING SYSTEM		
Lawn area (rec./up to)	8.000 m ² /h	8.000 m ² /h
Cutting width	107 cm	106 cm
Cutting height (min-max)	25–100 mm	25–100 mm
Cutting deck	stamped	stamped
Number of blades	2	2
Deck engagement	Electric PTO	Electric PTO
Deck height positions	12 positions	12 positions
Deck wheels	2 balls deck wheels	4 balls deck wheels
Wash nozzle/Mulch Kit/mulching blades	–/Standard/–	Standard/(196-550-000)/(196-560-000)
DISCHARGE SYSTEM		
Bag (capacity)/accessory no.	Optional 200 l/(19A30030100)	360 l, with Anti dust system/–
Bag lever/hardtop	–/–	Rounded ergo telescopic handle/Plastic
Bag fill indicator/grass deflector	–/Standard	Deluxe w Blade Shutoff/(196-552A000)
FRAME		
Front axle	Heavy-duty cast-iron	Heavy-duty cast-iron
Front bumper	Standard, blue	Bull Bar
Turning radius	TIGHT TURN xTREME 17 cm	TIGHT TURN xTREME 17 cm
Wheel size (f/r in inch)	15 x 6 Turf Saver / 20 x 8 Turf Saver	15 x 6 Turf Saver / 18 x 8,5
Wheel bearings	Sleeve bearings	Sleeve bearings
Frame	Fully robotically-welded frame	Fully robotically-welded frame
ELECTRIC		
Headlights	LED	LED
COMFORT		
Seat type	Cut & Sew, high back rest	Cut & Sew, high back rest, with arm rests
Seat adjustment	Lever, angled, 10 slide	Lever, angled, 10 slide
Steering wheel	Ergonomic with gentle touch	Ergonomic with gentle touch
Toolbox/Cupholder	Standard/Standard	Standard/Standard
Mow in reverse (RevTEK™)	Standard	Standard
DIMENSIONS		
LpA/LwA/LwAg (dB)	n.a./n.a./n.a.	88/98/100
Vibration value body / K-factor	1,0 / 0,5 m/s ²	1,0 / 0,5 m/s ²
Vibration value hand/arm / K-factor	5,0 / 1,5 m/s ²	5,0 / 1,5 m/s ²
Dimensions (L/W/H)	180 cm / 115 cm / 120 cm	267 cm / 110 cm / 118 cm
Net weight	245 kg	268 kg
PRICE		
Model number	33ABA7ES603	13AFASTR603
EAN		
Price	-	-

XT3 QS127

XT3 QS137

ENGINE		
Engine type	Kawasaki	Kawasaki
Engine displacement	726 cm ³	726 cm ³
Rated power	15,0 kW / 2.800 min ⁻¹	14,1 kW / 2.700 min ⁻¹
Cylinders	V-TWIN dual cylinder	V-TWIN dual cylinder
Tank volume (capacity)	11,4 l	11,4 l
DRIVE SYSTEM		
Transmission	Hydrostatic, All-Ground Traction System	Hydrostatic, All-Ground Traction System
Speeds	Infinitely variable (f/r)	Infinitely variable (f/r)
Control	Foot pedal control	Foot pedal control
Cruise control	Standard	Standard
CUTTING SYSTEM		
Lawn area (rec./up to)	10.000 m ² /h	11.000 m ² /h
Cutting width	127 cm	137 cm
Cutting height (min-max)	25–100 mm	25–100 mm
Cutting deck	stamped	welded mowing deck
Number of blades	3	3
Deck engagement	Electric PTO	Electric PTO
Deck height positions	12 positions	12 positions
Deck wheels	4 balls deck wheels + roller	4 balls deck wheels + roller
Wash nozzle/Mulch Kit/mulching blades	Standard/Standard/Standard	Standard/Standard/Standard
DISCHARGE SYSTEM		
Bag (capacity)/accessory no.	Optional 210 l/(19A30018100)	Optional 210 l/(19A30018100)
Bag lever/hardtop	–/–	–/–
Bag fill indicator/grass deflector	–/Standard	–/Standard
FRAME		
Front axle	Heavy-duty cast-iron	Heavy-duty cast-iron
Front bumper	Bull Bar	Bull Bar
Turning radius	TIGHT TURN xTREME 17 cm	TIGHT TURN xTREME 17 cm
Wheel size (f/r in inch)	16 x 6,5-8 Turf Saver / 22 x 9,5	16 x 6,5-8 Turf Saver / 22 x 9,5
Wheel bearings	Ball bearings	Ball bearings
Frame	Fully robotically-welded frame	Fully robotically-welded frame
ELECTRIC		
Headlights	LED	LED
COMFORT		
Seat type	Cut & Sew, high back rest, with arm rests	Cut & Sew, high back rest, with arm rests
Seat adjustment	Lever, angled, 10 slide	Lever, angled, 10 slide
Steering wheel	Ergonomic with gentle touch	Ergonomic with gentle touch
Toolbox/Cupholder	Standard/Standard	Standard/Standard
Mow in reverse (RevTEK™)	Standard	Standard
DIMENSIONS		
LpA/LwA/LwAg (dB)	93/103/105	93/103/105
Vibration value body / K-factor	1,0 / 0,5 m/s ²	1,0 / 0,5 m/s ²
Vibration value hand/arm / K-factor	5,0 / 1,5 m/s ²	5,0 / 1,5 m/s ²
Dimensions (L/W/H)	197 cm / 155 cm / 110 cm	197 cm / 167 cm / 110 cm
Net weight	260 kg	270 kg
PRICE		
Model number	14AFA5TQ603	14AFA5TM603
EAN		
Price	-	-



THE MOST COMPREHENSIVE RANGE OF ACCESSORIES FOR XT LAWN TRACTORS!

Whether it's transporting work material or cuttings, pushing seeds into the soil, spreading fertiliser, sweeping footpaths or clearing snow – the Cub Cadet XT lawn tractor can do so much more than just mow the lawn. The extensive range of Cub Cadet accessories, the largest range of its kind in Europe, will help to meet all the gardening requirements. This means you can use your XT lawn tractor all year round and it will pay for itself all the more quickly.



LAWN TRACTOR ACCESSORIES

	CUB CADET HAULER	
	Cub Cadet hauler with 450 kg load-bearing capacity	4 008423 887013 Mod. no.: 19B40026100R Price: -
	Handle	0 037049 959068 Mod. no.: 19A400270EM Price: -
	Tool holder	0 037049 959082 Mod. no.: 19A400300EM Price: -



HIGH LOAD CAPACITY

Rated to carry up to 450 kg with sides set upright and can easily haul soil or mulch, brick or stone, shrubs or plants, or even garbage bins.



REMOVABLE PANELS

Easier access for loading, unloading and dumping.



VERSATILE – LETS YOU DO MORE.

EASY FLAT-BED HAULING
Increase versatility by operating in fold-flat mode; ideal for longer loads like logs or lumber.

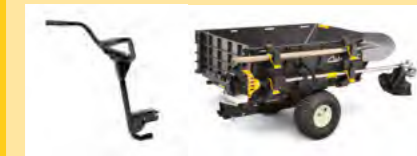

HANDLE AND TOOL HOLDER FOR CUB CADET HAULER

- Soft grip handle
- Flexible use
- Swift and simple assembly



FOLDABLE SIDES FOR EASY STORAGE

Collapse all four sides and store it vertically, taking up 70 % less space than traditional yard carts in a garage or shed.



TRANSPORT PLATFORM FOR XT SERIES SIDE DISCHARGER

- Foldable vertically and lockable in place
- Easy to install thanks to the FastAttach™ System
- Max. weight: 36 kg
- Suitable for XT Series side-dischargers



0 043033 577132
Mod. no.: 19A30029100
Price: -







ELECTRIC SPREADER FOR XT SERIES SIDE DISCHARGER

- Easy to install thanks to the FastAttach™ System
- Can be switched on/off from the driver's seat
- Capacity: 45 kg
- Suitable for XT Series side-dischargers



4 008423 875775
Mod. no.: 19A30028100
Price: -



	TOW BROADCAST SPREADER	
	<ul style="list-style-type: none"> • Capacity: 80 kg • Weight: 26 kg • Spreading width: up to 365 cm • Dimensions (L/W/H): 109 / 96,5 / 104 cm 	4 008423 816310 Mod. no.: 196-036-000 Price: -
	<ul style="list-style-type: none"> • Capacity: 50 kg 	4 008423 874129 Mod. no.: 196-545-000 Price: -
	<ul style="list-style-type: none"> • Capacity: 39 kg • Weight (approx.): 8 kg • Spreading width: up to 300 cm • Dimensions (L/W/H): 88,9 / 55,9 / 48,3 cm 	4 008423 875829 Mod. no.: 196-031B000 Price: -



	LAWN TRACTOR COVER L/XL	
	Size L: for small- and medium-sized lawn tractors	4 008423 806441 Mod. no.: 2024-U1-0003 Price: -
	Size XL: for large-sized and rear discharge lawn tractors (B)	4 008423 823882 Mod. no.: 2024-U1-0004 Price: -







	UTILITY CART WITH POLY BED	
	<ul style="list-style-type: none"> • Poly convertible push/tow cart, single-axle tipper • Capacity max.: 159 kg • Weight: 27 kg • Dimensions approx. (L/W/H): 142,2 / 83,8 / 76,2 cm 	4 008423 804331 Mod. no.: 190-236A000 Price: -
	<ul style="list-style-type: none"> • Poly convertible push/tow cart, single-axle tipper • Capacity max.: 175 kg • Weight: 30 kg 	4 008423 816396 Mod. no.: 196-506-000 Price: -
	<ul style="list-style-type: none"> • Tow steel dump cart, single-axle tipper, removable tailgate • Capacity max.: 159 kg • Dimensions approx. (L/W/H): 152,4 / 83,8 / 72 cm • Weight (approx.): 33 kg 	4 016918 006894 Mod. no.: 190-223B000 Price: -
	<ul style="list-style-type: none"> • Tow steel dump cart, single-axle tipper, removable tailgate • Capacity max.: 340 kg • Dimensions approx. (L/W/H): 177,8 / 83,8 / 73,7 cm • Weight (approx.): 70 kg 	4 008423 804348 Mod. no.: 196-507-000 Price: -



	SPRAYER	
	Tow sprayer, large, 6,8 l/min, capacity 95 l, dimensions approx. (L/W/H): 139,7 / 66 / 50,8 cm	4 008423 804430 Mod. no.: 190-537-000 Price: -

CUB CADET TOW BEHIND SWEEPER	
 <ul style="list-style-type: none"> Working width: 107 cm Catcher capacity: 380 litre Weight: 31,3 kg 	 <p>4 008423 807516 Mod. no.: 190-163A000 Price: -</p>
<ul style="list-style-type: none"> Working width: 112 cm Catcher capacity: 736 litre 	 <p>4 008423 858976 Mod. no.: 196-543-000 Price: -</p>



LAWN ROLLERS	
 <p>Push/tow poly lawn roller, max. weight 114 kg when filled with water, width 61 cm, diam. 46 cm, dimensions approx. (L/W/H): 127 / 76,2 / 46 cm</p>	 <p>4 008423 401264 Mod. no.: 190-228-000 Price: -</p>
<p>Tow poly lawn roller, max. weight 182 kg when filled with water, width 91 cm, diam. 46 cm, dimensions approx. (L/W/H): 127 / 106,7 / 46 cm</p>	 <p>4 008423 804478 Mod. no.: 190-229-000 Price: -</p>

AERATORS/DE-THATCHER	
 <p>Attachable lawn rake, working width 102 cm, 20 tines, variable load, dimensions (L/W/H): 104/101,6/104 cm</p>	 <p>4 008423 804454 Mod. no.: 190-526-000 Price: -</p>
<p>Tow-Lawn Aerator, working width 102 cm, 10 galvanised aerator stars, variable load by additional loading, up to 6 cm aeration depth</p>	 <p>4 008423 896367 Mod. no.: 196-094-000 Price: -</p>

MULCH KITS	
 <p>Mulch Kit (without blades) for model LT1 NS96 and LT2 NS96</p>	 <p>4 008423 819632 Mod. no.: OEM-190A116 Price: -</p>
 <p>Mulch Kit (without blades) for models LT1 NR92, LT2 NR92 and LT3 PR105</p>	 <p>4 008423 836080 Mod. no.: 196-749A678 Price: -</p>
<p>Mulch Kit (without blade) for models XT1 OR106, XT2 QR106, XT2 PR106i and XT3 QR106, mulching plug optional available (196-560-000)</p>	 <p>4 008423 875652 Mod. no.: 196-550-000 Price: -</p>
<p>Mulch Kit (without blade) for models XT1 OR95 and XT2 PR95, mulching plug optional available (196-561-000)</p>	 <p>4 008423 875669 Mod. no.: 196-551-000 Price: -</p>

AGRICULTURAL TIRES	
 <p>Chevron style rear wheels 18" x 9,5". Set consists of 2 cpl. wheels. Fits all tractors with either 18" or 20" rear wheels. Not approved for XT3 models.</p>	 <p>4 008423 816891 Mod. no.: 196-721A678 Price: -</p>





GRASS CATCHER	
 <p>Anti-Dust-System for 360 l grass collection system, XT3 Series</p>	 <p>4 008423 874976 Mod. no.: 196-553-603 Price: -</p>
<p>Anti-Dust-System for 320 l grass collection system, XT1 and XT2 Series</p>	 <p>4 008423 875089 Mod. no.: 196-555-603 Price: -</p>
<p>Twin bagger, 200 l, for 96 cm / 107 cm decks of LT Series</p>	 <p>4 008423 815849 Mod. no.: OEM-190-180A Price: -</p>
<p>Twin bagger, 200 l, for 96 cm decks of XT Series</p>	 <p>4 008423 883350 Mod. no.: OEMR190-180A Price: -</p>
 <p>Twin bagger for 200 l, for 107 / 117 cm, with variable tube, inspection window and FastAttach™ System, for decks of LT and XT Series</p>	 <p>4 008423 879636 Mod. no.: 19A30030100 Price: -</p>
<p>Triple bagger 210 l, for 127 / 137 cm decks of XT Series</p>	 <p>0 037049 957286 Mod. no.: 19A30018100 Price: -</p>

FRONT BUMPER	
 <p>Front bumper, fits all LT Series lawn tractors</p>	 <p>4 008423 917819 Mod. no.: OEM-190-679 Price: - €* /</p>
<p>Front Bumper Bull Bar, XT Series</p>	 <p>4 056494 171210 Mod. no.: 196-564-000 Price: -</p>

DEFLECTORS	
<p>Rear deflector for LT Series rear-discharger models</p>	 <p>4 008423 836097 Mod. no.: 196-750A678 Price: -</p>
<p>Deflector for all XT series rear discharge lawnmowers</p>	 <p>4 008423 899641 Mod. no.: 196-552A000 Price: -</p>

REAR HITCH	
<p>Rear hitch for LT series with rear discharge</p>	 <p>4 008423 914733 Mod. no.: 196-399-000 Price: -</p>

TIELBÜRGER FRONT ATTACHMENT SWEEPER AND ACCESSORIES (RE=REQUIRED | OP=OPTIONAL)

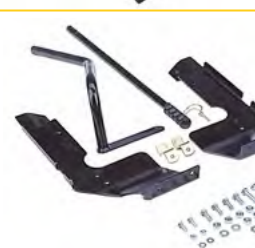
	Front attachment sweeper, 120 cm. Accessories for mounting are required. See below.	4 008423 883510 Mod. no.: 196-603-000 Price: -
	OP: Hopper for front attachment sweeper	4 008423 883527 Mod. no.: 196-604-000 Price: -
	RE: Quick-action coupling system with drive – attachment for front attachment sweeper and premium dozer blade	4 008423 883503 Mod. no.: 196-602-000 Price: -
	RE: For rear discharge Drive line	4 008423 885194 Mod. no.: 196-608-000 Price: -
	RE: For side discharge Drive line (up to and including date of manufacture 2017)	4 008423 885200 Mod. no.: 196-609-000 Price: -
	RE: For rear discharge Add-on parts	4 008423 885217 Mod. no.: 196-610-000 Price: -
	RE: For side discharge Add-on parts (up to and including date of manufacture 2017)	4 008423 885224 Mod. no.: 196-611-000 Price: -

TIELBÜRGER PREMIUM DOZER BLADE AND ACCESSORIES (RE=REQUIRED | OP=OPTIONAL)

	Premium dozer blade, 125 cm. Accessories for mounting are required. See below.	4 008423 883534 Mod. no.: 196-606-000 Price: -
	OP: Wheels for Premium dozer blade	4 008423 883541 Mod. no.: 196-607-000 Price: -
	RE: Quick-action coupling system without drive – attachment for premium dozer blade	4 008423 883497 Mod. no.: 196-601-000 Price: -
	OP: Quick-action coupling system with drive – attachment for front attachment sweeper and premium dozer blade	4 008423 883503 Mod. no.: 196-602-000 Price: -
	RE: For rear discharge Add-on parts	4 008423 885217 Mod. no.: 196-610-000 Price: -
	RE: For side discharge Add-on parts (up to and including date of manufacture 2017)	4 008423 885224 Mod. no.: 196-611-000 Price: -



TIRE CHAINS

For 20" x 8,0" wheels incl. Adapter	4 008423 824797 Mod. no.: 196-658-699 Price: -
For 18" x 9,5" wheels incl. Adapter	4 008423 813678 Mod. no.: 196-898-699 Price: -
For XT 22" x 9", 5" x 12" and 23" x 9", 5" x 12" wheels	0 037049 945597 Mod. no.: 490-241-0025 Price: -



DOZER BLADE AND RUBBER LIP

117 cm dozer blade for LT Series	4 008423 807684 Mod. no.: OEM-190-833 Price: -
Rubber lip – universal – for all dozer blades	4 008423 815368 Mod. no.: 196-718-678 Price: -
117 cm dozer blade for LT und XT Series	0 037049 957309 Mod. no.: 19A30017OEM Price: -
Installation Kit – for attaching OEM-190-833 in the XT Series	4 008423 879629 Mod. no.: 196-584-000 Price: -

ADDITIONAL XT ACCESSORIES

Battery charger for LR, LT and XT Series	4 008423 835694 Mod.-Nr.: 196-967-678 Preis: -
Electrical grass catcher emptying mechanism for XT Series rear discharger system. Only suitable for 2018 and later models.	4 008423 882025 Mod.-Nr.: 196-570-600 Preis: -
Mounted snow thrower for XT Series side discharger, 107 cm, 3-stepped	0 043033 573585 Mod.-Nr.: 19A40024100 Preis: -
Mounted snow thrower for XT Series rear discharger, 107 cm, 3-stepped	0 016918 038936 Mod.-Nr.: 19A40045OEM Preis: -
Fuel canister, 10 litre	4 008423 877540 Mod.-Nr.: 196-558-603 Preis: -

XZ3

ENDURO SERIES™

XZ6

ENDURO SERIES™



XZ3 122

Cutting width:	122 cm
Lawn area (rec.):	11.000 m ² /h
Collecting volume:	Optional 300 l
Engine:	Kawasaki OHV, V-TWIN dual cylinder
Engine displacement:	726 cm ³
Drive:	Dual Hydrostatic
Cutting height adjustment:	15 positions
Model no.:	47AIDGH8603
Price:	-



XZ6 S107

Cutting width:	107 cm
Lawn area (rec.):	10.000 m ² /h
Collecting volume:	Optional 230 l
Engine:	Cub Cadet, V-TWIN dual cylinder
Engine displacement:	679 cm ³
Drive:	Dual Hydrostatic
Cutting height adjustment:	15 positions
Model no.:	17AAGBYE603
Price:	-



XZ6 S117

Cutting width:	117 cm
Lawn area (rec.):	10.500 m ² /h
Collecting volume:	Optional 230 l
Engine:	Kawasaki, V-TWIN dual cylinder
Engine displacement:	726 cm ³
Drive:	Dual Hydrostatic
Cutting height adjustment:	15 positions
Model no.:	17AIGBYN603
Price:	-



XZ6 S127

Cutting width:	127 cm
Lawn area (rec.):	11.500 m ² /h
Collecting volume:	Optional 230 l
Engine:	Kawasaki, V-TWIN dual cylinder
Engine displacement:	726 cm ³
Drive:	Dual Hydrostatic
Cutting height adjustment:	15 positions
Model no.:	17AIGGY2603
Price:	-

SYNCHRO STEER® TECHNOLOGY



OUTSTANDING MANOEUVRABILITY AND SLOPE HANDLING The Cub Cadet Synchro Steer® Technology is the next step of the evolution of the Zero-Turn technique. Our unique Zero-Turn riders with a traditional steering wheel provide you with the amazing manoeuvrability of a conventional Zero-Turn but retaining full control of the front wheels. Steering and drive are perfectly synchronized to ensure the exact speed and rotation direction of each rear wheel, whatever the position of the front wheels. This revolutionary technology is available for the XZ3 and XZ6 Series.



Learn more

ZERO TURNING RADIUS – GREAT VARIETY

High-performance meets practicality for one strong rider. The industry's first zero-turn system with steering wheel control and four-wheel steering for unmatched strength and stability. From the power of a professional-grade engine to its unbeatable efficiency and durability, every mow is as strong as the last.



ADJUSTABLE STEERING COLUMN
The XZ3 and XZ6 models are equipped with an adjustable steering column so you can set your own comfy seating position.



PNEUMATIC CASTER WHEELS
Controllable pneumatic front caster wheels which support the Zero-Turn of your XZ.



ULTRA-BRIGHT LED HEADLIGHTS
Best visibility for XZ6 models in poor lighting conditions, e.g. at dawn and dusk.



ROBUST TUBULAR STEEL FRAME
A muscular tubular steel frame gives you optimal strength and durability to maneuver around obstacles with ease.



COMFORTABLE SEAT WITH ARMRESTS
An adjustable high-back seat with armrests makes hard work far more comfortable.



SOLID, WELDED MOWER DECKS
on all XZ3 and XZ6 models. For high durability and absolute robustness.

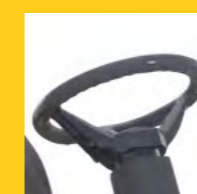

STEERING WHEEL
A soft grip steering wheel for best control, however tough the conditions.

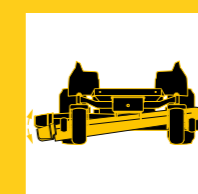

CLEAN CUT
The floating deck follows ground contours for superior cutting and a smoother and more uniform look.

XZ5 ENDURO SERIES™

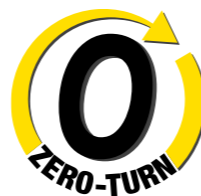

XZ5 L107 - ULTIMA

Cutting width:	107 cm
Lawn area (rec.):	10.000 m ² /h
Collecting volume:	Optional 230 l
Engine:	Cub Cadet, V-Twin dual cylinder
Engine displacement:	679 cm ³
Drive:	Dual Hydrostatic
Cutting height adjustment:	15 positions
Model no.:	17BAEACS603
Price:	-



XZ5 L127 - ULTIMA

Cutting width:	127 cm
Lawn area (rec.):	11.500 m ² /h
Collecting volume:	Optional 230 l
Engine:	Kawasaki OHV, V-Twin dual cylinder
Engine displacement:	726 cm ³
Drive:	Dual Hydrostatic
Cutting height adjustment:	15 positions
Model no.:	17AIEACL603
Price:	-



XZ5 L137 - ULTIMA

Cutting width:	137 cm
Lawn area (rec.):	12.500 m ² /h
Collecting volume:	Optional 230 l
Engine:	Kawasaki OHV, V-Twin dual cylinder
Engine displacement:	726 cm ³
Drive:	Dual Hydrostatic
Cutting height adjustment:	15 positions
Model no.:	17AIEAC3603
Price:	-

XZ5: BENEFIT FROM THE BEST IN CLASS

The innovative lap-bar technology combined with the extremely robust construction consisting of heavy-duty components and high-performance engines makes the XZ5 Series the ideal solution for large lawn areas.

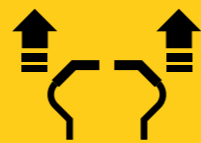

DRIVING FORWARD



TURNING TO THE RIGHT

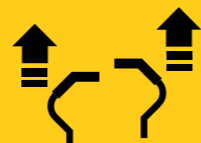

TURNING TO THE LEFT



DRIVING REVERSE



EXECUTING A ZERO-TURN



Learn more



EXTREMELY RUGGED

The XZ5 models have an extremely robust steel mowing deck and a light-weight tubular steel frame, giving them an extremely long service-life.



ULTRA-BRIGHT LED HEADLIGHTS

Best visibility in poor lighting conditions, e.g. at dawn and dusk.



EXCEPTIONALLY LOW VIBRATION

With ergonomic soft grips and rubber floor mats.



INDIVIDUALLY ADJUSTABLE SEAT

With high back and armrests for comfortable, fatigue-free operation.



EXTREMELY POWERFUL

Driven by powerful Cub Cadet and Kawasaki engines, the XZ5 models reach speeds of up to 12 km/h, enabling them to mow up to 50 % faster than conventional front cut mowers.



LARGEST TIRES IN ITS CLASS

The premium tires of the XZ5 127 and XZ5 137 models provide better traction. They also offer more stability and control.

SOLID ROLLOVER PROTECTION
Fully welded tubular steel frame for maximum safety already as standard equipment.

XZ7 ENDURO SERIES™

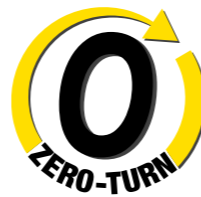

**3-in-1
OPTION**
Powered by
KAWASAKI

XZ7 L122 - ULTIMA

Cutting width:	122 cm
Lawn area (rec.):	11.000 m ² /h
Collecting volume:	Optional 380 l
Engine:	Kawasaki, V-TWIN dual cylinder
Engine displacement:	726 cm ³
Drive:	Dual Hydrostatic
Cutting height adjustment:	16 positions
Model no.:	47AIAAA6603
Price:	-



**3-in-1
OPTION**
POWERED BY
KOHLER

XZ7 L152i - ULTIMA

Cutting width:	152 cm
Lawn area (rec.):	15.000 m ² /h
Collecting volume:	Optional 380 l
Engine:	KOHLER EFI, V-TWIN dual cylinder
Engine displacement:	747 cm ³
Drive:	Dual Hydrostatic
Cutting height adjustment:	16 positions
Model no.:	47ATAHA8603
Price:	-



To the videos

DESIGNED FOR EVERY CHALLENGE

The top-of-the-line model in the ENDURO XZ Series makes a great impression with its improved stability and durability. You can easily mow with maximum comfort even under the most difficult conditions.



ROBUST MOWING DECK

The robust tubular steel frame as well as the welded, all-round reinforced AeroForce Max™ mowing deck for ultimate bagging performance provides the necessary strength for a consistently high cut quality.



SPRING-MOUNTED FRONT-WHEEL SUSPENSION

The individually-suspended wheels ensure a smooth ride with less vibration, even on the most difficult lawns.



MAXIMUM COMFORT

The premium seat with a high backrest has padded armrests and special cushioning. This significantly reduces vibrations even at high speeds.



INFINITE DIVERSITY

In addition to the included mulching kit the standard rear hitch gives you the option to combine your XZ7 with a wide variety of accessories.



OUTSTANDING GRASS COLLECTION

The AeroForce Max™ mowing deck uses the air flow from the rotating blades to propel the grass clippings in a high arc into the optionally available collecting basket. This fills the bag to the top without clumping.



GUARANTEED DURABILITY

We trust our new XZ7 models with maximum durability and robustness and offer a warranty of 3 years or up to 500 working hours* – for commercial or private use.

TOP SPEED

With a top speed of up to 14,5 km/h, even the largest lawns are mowed in no time.

ULTRA-BRIGHT LED HEADLIGHTS

Best visibility when working at dawn and dusk.

NEW
XZ6 S107

NEW
XZ6 S117



NEW
XZ6 S127

ENGINE			
Engine type	Cub Cadet	Kawasaki	Kawasaki
Engine displacement	679 cm ³	726 cm ³	726 cm ³
Rated power	14,9 kW / n.a. min ⁻¹	16,9 kW / n.a. min ⁻¹	16,9 kW / n.a. min ⁻¹
Cylinders	V-TWIN dual cylinder	V-TWIN dual cylinder	V-TWIN dual cylinder
Tank volume (capacity)	13,25 l	13,25 l	13,25 l
Lubrication	Full-pressure with spin-on oil filter	Full-pressure with spin-on oil filter	Full-pressure with spin-on oil filter
DRIVE SYSTEM			
Transmission	Dual Hydrostatic	Dual Hydrostatic	Dual Hydrostatic
Control	Dual foot pedal control	Dual foot pedal control	Dual foot pedal control
Cruise control	-	-	-
CUTTING SYSTEM			
Lawn area (rec./up to)	10.000 m ² /h	10.500 m ² /h	11.500 m ² /h
Cutting width	107 cm	117 cm	127 cm
Cutting height (min-max)	25–114 mm	25–114 mm	25–114 mm
Cutting options	3-in-1 option	3-in-1 option	3-in-1 Option
Number of blades	2	2	3
Deck engagement	Electric PTO	Electric PTO	Electric PTO
Deck height positions	15 positions	15 positions	15 positions
Deck wheels	2	2	3
Wash nozzle/Mulch Kit	-/Standard	-/Standard	-/Standard
DISCHARGE SYSTEM			
Bag (capacity in l)/accessory no.	Optional 230 l/(19A70054100 + 490-950-C062)	Optional 230 l/(19A70054100 + 490-950-C062)	Optional 230 l/(19A70054100 + 490-950-C062)
Grass deflector	Standard	Standard	Standard
FRAME			
Front axle	Steel	Steel	Steel
Front bumper/rear bumper	- / -	- / -	- / -
Turning radius (cm)	0 cm	0 cm	0 cm
Wheel size (f/r in inch)	13 x 6,5 / 20 x 8	13 x 6,5 / 20 x 10	13 x 6,5 / 20 x 12
Wheel bearings	Sleeve bearings	Sleeve bearings	Ball-bearings
ELECTRICAL SYSTEM			
Battery	12 V / 230 CCA	12 V / 230 CCA	12 V / 230 CCA
Headlights	-	-	-
Hour metre/service minder	Standard	Standard	Standard
Safety systems	Operator presence, brake switch, deck clutch switch	Operator presence, brake switch, deck clutch switch	Operator presence, brake switch, deck clutch switch
COMFORT			
Seat type	High back with arm rests	High back, with arm rests	High back, with arm rests
Seat adjustment	Quick adjuster lever	Quick adjuster lever	Quick adjuster lever
Steering wheel	Soft-Grip, tilt steering column	Soft-Grip, tilt steering column	Soft-Grip, tilt steering column
Utility bin	Standard	Standard	Standard
Mow in reverse	Standard	Standard	Standard
DIMENSIONS			
LpA/LwA/LwAg (dB)	n.a./n.a./n.a.	n.a./n.a./n.a.	n.a./n.a./n.a.
Vibration value body/K-factor	1,0 / 0,5 m/s ²	1,0 / 0,5 m/s ²	1,0 / 0,5 m/s ²
Vibration value hand/arm / K-factor	5,0 / 1,5 m/s ²	5,0 / 1,5 m/s ²	5,0 / 1,5 m/s ²
Dimensions (L/W/H)	203 cm / 132 cm / 114 cm	203 cm / 155 cm / 114 cm	203 cm / 126 cm / 118 cm
Net weight	267 kg	285 kg	265 kg
PRICE			
Model number	17AAGBYE603	17AIGBYN603	17AIGGY2603
EAN	 4 008423 922578	 4 008423 922684	 4 008423 922691
Price	-	-	-

XZ3 122

XZ5 L107 - ULTIMA

XZ5 L127 - ULTIMA

ENGINE			
Engine type	Kawasaki OHV	Cub Cadet	Kawasaki OHV
Engine displacement	726 cm ³	679 cm ³	726 cm ³
Rated power	12,3 kW / 2.750 min ⁻¹	11,4 kW / 2.350 min ⁻¹	14,1 kW / 2.800 min ⁻¹
Cylinders	V-TWIN dual cylinder	V-Twin dual cylinder	V-Twin dual cylinder
Tank volume (capacity)	17,0 l	13,25 l	13,25 l
Lubrication	Full-pressure with spin-on oil filter	Full-pressure with spin-on oil filter	Full-pressure with spin-on oil filter
DRIVE SYSTEM			
Transmission	Dual Hydrostatic	Dual Hydrostatic	Dual Hydrostatic
Control	Dual foot pedal control	Control lever	Control lever
Cruise control	Standard	-	-
CUTTING SYSTEM			
Lawn area (rec./up to)	11.000 m ² /h	10.000 m ² /h	11.500 m ² /h
Cutting width	122 cm	107 cm	127 cm
Cutting height (min-max)	25–102 mm	25–115 mm	25–115 mm
Cutting options	3-in-1 Option	3-in-1 Option	3-in-1 Option
Number of blades	3	2	3
Deck engagement	Electric PTO	Electric PTO	Electric PTO
Deck height positions	15 positions	15 positions	15 positions
Deck wheels	2	2	3
Wash nozzle/Mulch Kit	Standard/Standard	Standard/Standard	Standard/Standard
DISCHARGE SYSTEM			
Bag (capacity in l)/accessory no.	Optional 300 l/(19A70040100)	Optional 230 l/(19A70054100)	Optional 230 l/(19A70055100)
Grass deflector	Standard	Standard	Standard
FRAME			
Front axle	Steel	Steel	Steel
Front bumper/rear bumper	Standard / -	- / Tubular steel frame	- / Tubular steel frame
Turning radius (cm)	0 cm	0 cm	0 cm
Wheel size (f/r in inch)	13 x 5 / 20 x 10	11 x 6 / 20 x 8	11 x 6 / 20 x 10
Wheel bearings	Ball-bearings	-	-
ELECTRICAL SYSTEM			
Battery	12 V / 230 CCA	12 V / 230 CCA	12 V / 230 CCA
Headlights	-	LED	LED
Hour metre/service minder	Standard	Standard	Standard
Safety systems	Operator presence, brake switch, deck clutch switch	Standard	-
COMFORT			
Seat type	High back with armrests	High back, with arm rests	High back with armrests
Seat adjustment	Quick adjuster lever	Quick adjuster lever	Quick adjuster lever
Steering wheel	Soft-Grip	2-way adjustable lap bars with comfort grips	2-way adjustable lap bars with comfort grips
Utility bin	Standard	Standard	Standard
Mow in reverse	Standard	Standard	Standard
DIMENSIONS			
LpA/LwA/LwAg (dB)	93/103/105	88/98/100	93/103/105
Vibration value body/K-factor	1,0 / 0,5 m/s ²	1,0 / 0,5 m/s ²	1,0 / 0,5 m/s ²
Vibration value hand/arm / K-factor	5,0 / 1,5 m/s ²	5,0 / 1,5 m/s ²	5,0 / 1,5 m/s ²
Dimensions (L/W/H)	194 cm / 124 cm / 118 cm	203 cm / 132 cm / 114 cm	203 cm / 155 cm / 114 cm
Net weight	312 kg	267 kg	285 kg
PRICE			
Model number	47AIDGHB603	17BAEACS603	17AIEACL603
EAN	 4 008423 875461	 4 008423 913187	 4 008423 913170
Price	-	-	-

XZ5 L137 - ULTIMA XZ7 L122 - ULTIMA XZ7 L152i - ULTIMA

ENGINE			
Engine type	Kawasaki OHV	Kawasaki	KOHLER EFI
Engine displacement	726 cm ³	726 cm ³	747 cm ³
Rated power	14,7 kW / 2.900 min ⁻¹	14,4 kW / 2.700 min ⁻¹	14,8 kW / 2.700 min ⁻¹
Cylinders	V-Twin dual cylinder	V-TWIN dual cylinder	V-TWIN dual cylinder
Tank volume (capacity)	13,25 l	20,8 l	20,8 l
Lubrication	Full-pressure with spin-on oil filter	Full-pressure with spin-on oil filter	Full-pressure with spin-on oil filter
DRIVE SYSTEM			
Transmission	Dual Hydrostatic	Dual Hydrostatic	Dual Hydrostatic
Control	Control lever	Control lever	Control lever
Cruise control	-	-	Standard
CUTTING SYSTEM			
Lawn area (rec./up to)	12.500 m ² /h	11.000 m ² /h	15.000 m ² /h
Cutting width	137 cm	122 cm	152 cm
Cutting height (min-max)	25-115 mm	25-114 mm	25-114 mm
Cutting options	3-in-1 Option	3-in-1 option	3-in-1 option
Number of blades	3	3	3
Deck engagement	Electric PTO	Electric PTO	Electric PTO
Deck height positions	15 positions	16 positions	16 positions
Deck wheels	3	2	2 + Nose
Wash nozzle/Mulch Kit	Standard/Standard	-/Standard	-/Standard
DISCHARGE SYSTEM			
Bag (capacity in l)/accessory no.	Optional 230 l/(19A70055100)	Optional 380 l/(49A70001100)	Optional 380 l/(49A70002100)
Grass deflector	Standard	Standard	Standard
FRAME			
Front axle	Steel	Steel, with front wheel suspension	Steel, with front wheel suspension
Front bumper/rear bumper	- / Tubular steel frame	- / Tubular steel frame	- / Tubular steel frame
Turning radius (cm)	0 cm	0 cm	0 cm
Wheel size (f/r in inch)	13 x 6,5 / 20 x 12	13 x 6,5 / 23 x 12	13 x 6,5 / 24 x 12
Wheel bearings	-	n.a.	n.a.
ELECTRICAL SYSTEM			
Battery	12 V / 230 CCA	12 V / 230 CCA	12 V / 230 CCA
Headlights	LED	LED	LED
Hour metre/service minder	Standard	Standard	Standard
Safety systems	Standard	Standard	Standard
COMFORT			
Seat type	High back with armrests	Premium, high back with armrests	Premium, high back with armrests, individually adjustable suspension
Seat adjustment	Quick adjuster lever	Quick adjuster lever	Quick adjuster lever
Steering wheel	2-way adjustable lap bars with comfort grips	2-way adjustable lap bars with comfort grips	2-way adjustable lap bars with comfort grips
Utility bin	Standard	Standard	Standard
Mow in reverse	Standard	Standard	Standard
DIMENSIONS			
LpA/LwA/LwAg (dB)	93/103/105	93/103/105	93/103/105
Vibration value body/K-factor	1,0 / 0,5 m/s ²	1,0 / 0,5 m/s ²	1,0 / 0,5 m/s ²
Vibration value hand/arm / K-factor	5,0 / 1,5 m/s ²	5,0 / 1,5 m/s ²	5,0 / 1,5 m/s ²
Dimensions (L/W/H)	203 cm / 164 cm / 117 cm	232 cm / 145 cm / 134 cm	233 cm / 177 cm / 134 cm
Net weight	312 kg	415 kg	450 kg
PRICE			
Model number	17AIEAC3603	47AIAAA6603	47ATAHA8603
EAN	4 008423 913163	4 008423 916805	4 008423 916812
Price	-	-	-

ZERO-TURNS ACCESSORIES

	Twin bagger, 200 l, for XZ2 117i	0 037049 957835	Mod. no.: 19C70020100 Price: -
	Twin bagger, 200 l, for XZ2 127	0 043033 565085	Mod. no.: 19A70043100 Price: -
	Triple bagger, 300 l, for XZ3 122	0 043033 565054	Mod. no.: 19A70040100 Price: -
	Cub Cadet RZT Twin Bagger, 107 cm, 230 litres for XZ5	4 008423 913361	Mod. no.: 19A70054100 Price: -
	Cub Cadet RZT Twin Bagger, 127 / 137 cm, 230 litres for XZ5	0 037049 965410	Mod.-Nr.: 19A70055100 Preis: -
	Triple Bagger 380 l, for XZ7 with 122cm cutting width	4 008423 917987	Mod.-Nr.: 49A70001100 Preis: -
	Triple Bagger 380 l, for XZ7 with 152cm cutting width	4 008423 917994	Mod. no.: 49A70002100 Price: -
	Weight kit for use with the grass catcher of all XZ6 models	0 889021 302702	Mod. no.: 490-950-C062 Price: -
	HITCH / XZ		
	Hitch for all XZ models	0 043033 565054	Mod. no.: 19A70025100 Price: -





PRO Z SERIES



BUILT USING THE HIGHEST QUALITY COMPONENTS SOURCED LOCALLY AND GLOBALLY

DURABILITY – HEAVIEST DUTY

From the frame to the front yoke, every part of the PRO Z is designed to handle serious rigors. The thickness of the cutting deck establishes a new industry standard, while an all-around heavy-duty construction ensures this zero-turn will last for the long haul.

COMFORT – WORK HARD. RIDE EASY

The PRO Z can take a beating, but your body shouldn't. Enjoy a smoother ride all day long with the enhanced comfort features of the PRO Z Series.

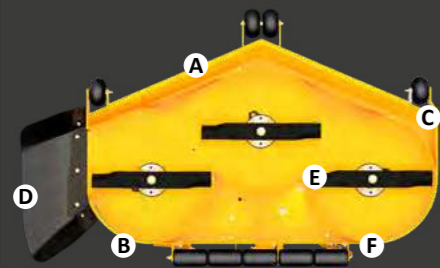

THE THICKEST, STRONGEST STEEL DECK IN THE INDUSTRY
Tackle the toughest conditions with the industry's only triple-7-gauge steel cutting deck: a 7-gauge deck shell with 7-gauge top and bottom reinforcements.

DURABILITY

- A 1/4" leading rolled edge
- B 5/16" steel side reinforcements
- C 3/4" wear guard

QUALITY CUT

- D Flexible rubber discharge chute
- E High-lift Marbain® blades (with blade tip speed up to 18,500 fpm)
- F Adjustable rear stripping roller

BEEFED-UP FRONT END
Absorb the impact of rough terrain with a new front-end construction featuring a best-in-class combination of axle, hub and yoke size.



- A 2" x 3" pivoting front axle
- B Isolation damping system
- C 5" steel hubs
- D 1/2" thick steel front yokes



PRO Z AIR-RIDE SEAT

Our exclusive air-ride seat allows riders to adjust the seat firmness to their personal preference.

- A Isolation damping system under the seat (PRO Z 5/7/9)
- B Lumbar support
- C EVC cushion (elastic vibration control)
- D Angle adjustment
- E Padded armrests



PIVOTING FRONT AXLE

A pivoting front axle allows the front end of the PRO Z to negotiate unseen terrain while protecting the quality of the cut. The frame and axle float as the PRO Z moves, allowing the deck to follow the terrain profile and avoid scalping.



Z1 137

The new Zero-Turn Z1 137 exceeds your expectations, not your budget. Equipped with a powerful cutting deck, it always delivers professional-quality results. Its outstanding speed, efficiency and comfort impress anybody who works daily with this Zero-Turn mower.



KOHLER CONFIDANT
EFI EZT 745

Z1 137 
TOP EFFICIENCY.
UNBELIEVABLE
MANEUVERABILITY.

POWERED BY
KOHLER.



- A POWER MACHINE**
With its fast speed of 15 km/h, the Z1 137 is at least twice as fast as a normal lawn tractor, excelling in efficiency.
- B MORE COMFORTABLE THAN EVER**
High-comfort seat, suspension and non-slip controls guarantee safe and fatigue-free work.
- C MARKET-LEADING EFFICIENCY**
25 % less fuel consumption with electronic fuel injection (EFI).
- D STRONG AND ROBUST**
Welded mowing deck with 137 cm cutting width for endless power.
- E EXTREMELY AGILE**
The unique 360° turning radius technology helps you negotiate tight corners and obstacles easily.

Cutting width:	137 cm
Area performance (rec.):	13.500 m ² /h
Discharge type:	Side discharge
Engine:	KOHLER Confidant EFI EZT 745, V-TWIN dual cylinder
Engine displacement:	747 cm ³
Drive:	Dual Hydrostatic
Transmission:	Hydrogear ZT3400
Max. speed:	15 km/h (forward)/7 km/h (reverse)
Cutting height adjustment:	17 positions

Model no.: 53CWEFJA603

Price: -



KAWASAKI OHV
V-TWIN DUAL CYLINDER

Z5 152 & Z7 183

Amazing strength and unsurpassed comfort – the perfect combination for true professionals! The Z5 152 offers performance, quality and efficiency that put other leading Zero-Turn mowers in the shade. This makes the Z7 183 the absolute top model that needs much less mowing time than any other product. However much you demand from a mower, you will love it!



KAWASAKI 31 HP ENGINE
A super-strong and efficient drive to meet optimal requirements (Z7 183).

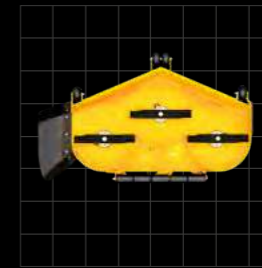

STRONGEST MOWING DECK ON THE MARKET
With its massive cutting width of 183 cm, cover more ground than any other mower (Z7 183).

Z5 152

STRENGTH IN EVERY DETAIL.

Powered by
Kawasaki



Cutting width:	152 cm
Area performance (rec.):	15.000 m ² /h
Discharge type:	Side discharge
Engine:	Kawasaki OHV, V-TWIN dual cylinder
Engine displacement:	852 cm ³
Drive:	Dual Hydrostatic
Transmission:	Parker HTG 12 cc
Max. speed:	16 km/h (forward)/8 km/h (reverse)
Cutting height adjustment:	17 positions

Model no.: 53BIHJUV603

Price: -

Z7 183

THE ABSOLUTE POWER PACK FOR TOP REQUIREMENTS.

Powered by
Kawasaki



Cutting width:	183 cm
Lawn area (rec.):	18.000 m ² /h
Discharge type:	Side discharge
Engine:	Kawasaki OHV, V-TWIN dual cylinder
Engine displacement:	999 cm ³
Drive:	Dual Hydrostatic
Transmission:	Parker HTG 14 cc
Max. speed:	19,5 km/h (forward)/10 km/h (reverse)
Cutting height adjustment:	17 positions

Model no.: 53AIHKUY603

Price: -



Z9 183id

MADE FOR
EVERY SLOPE

Powered by
Kawasaki

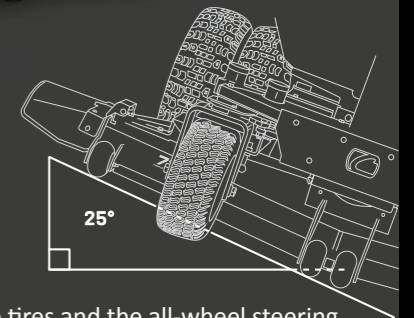

BEST MOWING PERFORMANCE

Thanks to the outstanding technical equipment, straight mowing lines, zero radius turns and mowing on steep slopes are easy.

WORK EFFORTLESSLY AND DRIVE COMFORTABLY

With the comfort features, you can enjoy a relaxed ride all day long. With the exclusive air ride seat, you can adjust the seat firmness according to your personal preferences.

ELECTRONICALLY ADJUSTABLE CUTTING DECK

Adjust the cutting deck to the specific requirements with just the touch of a button.

UNMATCHED CLIMBING ABILITIES

Extremely wide double tires and the all-wheel steering ensure maximum stability and precision even on steep slopes with inclines of up to 25°.

POWER AND ECONOMY COMBINED

Thanks to the electronic direct injection, the robust Kawasaki engine combines maximum performance with comparatively low fuel consumption.

RELIABLE AND SAFE

Cub Cadet gives you a guarantee of 1.000 working hours or 3 years* on the new Z9 183id.



KAWASAKI FX 1000V EFI
V-TWIN DUAL CYLINDER

Z9 183id



The new Z-Turn Z9 183id is a commercial zero-turn mower with extremely wide double tires – developed to effortlessly tackle even the steepest slopes of up to 25° (46%). In addition, it has an impressive extremely robust and multi-reinforced steel cutting deck, outstanding mowing performance and air-cushioned seating comfort. This top-of-the-line zero turn is ideal for municipalities, commercial users and owners of large properties with challenging terrain.

Cutting width:	183 cm
Lawn area (rec.):	18.000 m ² /h
Discharge type:	Side discharge
Engine:	Kawasaki FX1000V EFI, V-TWIN dual cylinder
Engine displacement:	999 cm ³
Drive:	Dual Hydrostatic
Transmission:	Parker HTG 16 cc
Max. speed:	19,5 km/h (drive) / 10,0 km/h (reverse)
Cutting height adjustment:	17 positions

Model no.: 53ALHMUY603

Price: -

	Z1 137	Z5 152
ENGINE		
Engine type	KOHLER Confidant EFI EZT 745	Kawasaki OHV
Engine displacement	747 cm ³	852 cm ³
Rated power	14,4 kW / 2.300 min ⁻¹	17,2 kW / 2.500 min ⁻¹
Cylinders	V-TWIN dual cylinder	V-TWIN dual cylinder
Tank volume (capacity)	2 x 15 l	2 x 34 l
Drive	Dual Hydrostatic	Dual Hydrostatic
Transmission	Hydrogear ZT3400	Parker HTG 12 cc
Lubrication	Pressure oil lubrication	Pressure oil lubrication
CUTTING SYSTEM		
Lawn area (rec./up to)	13.500 m ² /h	15.000 m ² /h
Cutting width	137 cm	152 cm
Cutting height (min-max)	26-127 mm	26-127 mm
Cutting options	2-in-1	2-in-1
Number of blades	3	3
Deck engagement	Electric PTO	Electric PTO
Deck height positions	17 positions	17 positions
Deck wheels	4 + 2 Nose	4 + 2 front roller
Mulch Kit	Standard	Standard
DISCHARGE SYSTEM		
Ejection type	Side discharge	Side discharge
Grass deflector	Standard	Standard
FRAME		
Front bumper/rear bumper	- / Standard	- / Standard
Turning radius	0 cm	0 cm
Wheel size (f/r in inch)	13 x 6,5 / 24 x 12	15 x 6 / 24 x 12
Wheel bearings	Ball bearings	Ball bearings
ELECTRICAL SYSTEM		
Battery	230 CCA	230 CCA
Headlights	-	-
Hour metre/service minder	Standard	Standard
Safety systems	Rollover bar	Rollover bar
COMFORT		
Seat type	High back, adjustable	High back with armrests, adjustable
Seat adjustment	Quick adjuster lever	Quick adjuster lever
Steering wheel	Soft-Grip	Soft-Grip
Utility bin	-	-
Mow in reverse	Standard	Standard
Battery charger	-	-
DIMENSIONS		
LpA/LwA/LwAg (dB)	93/103/105	93/103/105
Vibration value body/K-Faktor	1,0 / 0,5 m/s ²	1,0 / 0,5 m/s ²
Vibration value hand/arm / K-Faktor	5,0 / 1,5 m/s ²	5,0 / 1,5 m/s ²
Dimensions (L/W/H)	180 cm / 145 cm / 130 cm	230 cm / 160 cm / 134 cm
Net weight	360 kg	680 kg
PRICE		
Model number	53CWEFJA603	53BIHJUV603
EAN	 4 008423 874273	 4 008423 872415
Price	-	-

	Z7 183	Z9 183id
ENGINE		
Engine type	Kawasaki OHV	Kawasaki FX1000V EFI
Engine displacement	999 cm ³	999 cm ³
Rated power	21 kW / 2.600 min ⁻¹	28 kW / 2.600 min ⁻¹
Cylinders	V-TWIN dual cylinder	V-TWIN dual cylinder
Tank volume (capacity)	2 x 34 l with fuel gauge	2 x 34 l, with fuel indicator
Drive	Dual Hydrostatic	Dual Hydrostatic
Transmission	Parker HTG 14 cc	Parker HTG 16 cc
Lubrication	Pressure oil lubrication	Pressure oil lubrication
CUTTING SYSTEM		
Lawn area (rec./up to)	18.000 m ² /h	18.000 m ² /h
Cutting width	183 cm	183 cm
Cutting height (min-max)	26-127 mm	26-127 mm
Cutting options	2-in-1	2-in-1
Number of blades	3	3
Deck engagement	Electric PTO	Electric PTO
Deck height positions	17 positions	17 positions
Deck wheels	4 + 2 Nose + 1 deck rear rollers	4 + 2 roller
Mulch Kit	Standard	Standard
DISCHARGE SYSTEM		
Ejection type	Side discharge	Side discharge
Grass deflector	Standard	Standard
FRAME		
Front bumper/rear bumper	- / Standard	- / Standard
Turning radius	0 cm	0 cm
Wheel size (f/r in inch)	16 x 6,5 / 24 x 12	16 x 6,5 / 24 x 12
Wheel bearings	Ball bearings	n.a.
ELECTRICAL SYSTEM		
Battery	230 CCA	12 V / 230 CCA
Headlights	-	-
Hour metre/service minder	Standard	Standard
Safety systems	Rollover bar	Rollover bar
COMFORT		
Seat type	High back with armrests, adjustable	High back with armrests, individually adjustable
Seat adjustment	Quick adjuster lever	Quick adjuster lever
Steering wheel	Soft-Grip	Soft-Grip
Utility bin	-	Standard
Mow in reverse	Standard	Standard
Battery charger	-	-
DIMENSIONS		
LpA/LwA/LwAg (dB)	93/103/105	93/103/105
Vibration value body/K-Faktor	1,0 / 0,5 m/s ²	1,0 / 0,5 m/s ²
Vibration value hand/arm / K-Faktor	5,0 / 1,5 m/s ²	5,0 / 1,5 m/s ²
Dimensions (L/W/H)	226 cm / 185 cm / 131 cm	226 cm / 185 cm / 131 cm
Net weight	732 kg	840 kg
PRICE		
Model number	53AIHKUY603	53ALHMUY603
EAN	 4 008423 881929	 4 008423 917482
Price	-	-

PRO SERIES ACCESSORIES

	SNOW CHAINS	
	Snow chains for Z1	0 037049 945603 Mod. no.: 490-241-0026 Price: -
	Snow chains for Z5 and Z7	0 037049 951123 Mod. no.: 490-241-0036 Price: -

	DOZER BLADE	
	Dozer blade for Z5 and Z7	0 043033 580255 Mod. no.: 59B30036150 Price: -

	ELECTRIC DECK LIFT KIT	
	Electric deck lift for Z1	4 008423 881189 Mod. no.: 19B70045100 Price: -

	HEAVY DUTY LAWN STRIPING KIT	
	Heavy duty lawn striping Kit for Z1	0 043033 542109 Mod. no.: 19A70019100 Price: -
	Heavy duty lawn striping Kit for Z7 and Z9	0 889021 121587 Mod. no.: 59A30052150 Price: -



ACCESSORIES OVERVIEW

MOD. NO.	DESCRIPTION	EAN CODE	PRICE	LT1 NR92	LT1 NS96	LT2 NR92	LT2 NS96	LT3 PR105	LT3 PS107	XT1 OR95	XT1 OS96	XT1 OR106	XT1 OS107	XT2 PR95	XT2 QR106	XT2 PR106	XT2 PS107	XT2 PS117	XT2 ES107	XT2 QS117	XT3 QR106	XT3 QS127	XT3 QS137
LAWN TRACTORS ACCESSORIES																							
REAR ACCESSORIES																							
190-236A000	Transport trailer with plastic tub, max. 159 kg	4008423804331	-	•	•	•	•	•	•	•	•	•	•	•	•	•	•	•	•	•	•	•	•
196-506-000	Transport trailer with plastic tub, max. 175 kg	4008423816396	-	•	•	•	•	•	•	•	•	•	•	•	•	•	•	•	•	•	•	•	•
190-223B000	Steel transport trailer, max. 159 kg	4016918006894	-	•	•	•	•	•	•	•	•	•	•	•	•	•	•	•	•	•	•	•	•
196-507-000	Steel transport trailer, max. 340 kg	4008423804348	-	•	•	•	•	•	•	•	•	•	•	•	•	•	•	•	•	•	•	•	•
19A30029100	Rear transport platform for XT Series side discharger system	0043033577132	-							•		•					•	•	•	•		•	•
19A30028100	Rear-mount electrical spreader for XT Series side discharger system	4008423875775	-							•		•					•	•		•		•	•
196-031B000	Trailer spreader, capacity: 39 kg, spreading width 300 cm	4008423875829	-	•	•	•	•	•	•	•	•	•	•	•	•	•	•	•	•	•	•	•	•
196-545-000	Trailer spreader, capacity: 80 kg, spreading width 365 cm	4008423874129	-	•	•	•	•	•	•	•	•	•	•	•	•	•	•	•	•	•	•	•	•
196-036-000	Tow broadcast spreader 110 lbs	4008423816310	-	•	•	•	•	•	•	•	•	•	•	•	•	•	•	•	•	•	•	•	•
190-537-000	Trailer sprayer, spraying rate 6,8 l/min, capacity 95 l	4008423804430	-	•	•	•	•	•	•	•	•	•	•	•	•	•	•	•	•	•	•	•	•
196-543-000	Towed lawn and leaf sweeper, 112 cm	4008423858976	-	•	•	•	•	•	•	•	•	•	•	•	•	•	•	•	•	•	•	•	•
190-163A000	Towed lawn and leaf sweeper, 107 cm	4008423807516	-	•	•	•	•	•	•	•	•	•	•	•	•	•	•	•	•	•	•	•	•
196-570-600	Electr. grass catcher emptying mechanism for XT Series rear discharge	4008423882025	-							•		•		•	•	•					•		
OEM-190-180A	Dual-bag 200 l grass catcher for 96/107 cm LT Series mowing decks	4008423815849	-		•		•		•		•												
OEMR190-180A	Dual-bag 200 l grass catcher for 96 cm XT Series mowing decks	4008423883350	-							•													
19A30030100	Dual-bag 200 l grass catcher for 107/117 cm XT Series mowing decks	4008423879636	-										•				•	•	•	•			
19A30018100	Triple-bag grass catcher, 210 l, for 127/137 cm XT Series mowing decks	0037049957286	-																			•	•
196-555-603	Anti-dust system for XT Series 320 l grass collection system	4008423875089	-							•		•		•	•								
196-553-603	Anti-dust system for XT Series 360 l grass collection system	4008423874976	-																		•		
190-228-000	Lawn roller, width 61 cm, max. weight 114 kg	4008423401264	-	•	•	•	•	•	•	•	•	•	•	•	•	•	•	•	•	•	•	•	•
190-229-000	Lawn roller, width 92 cm, max. weight 182 kg	4008423804478	-	•	•	•	•	•	•	•	•	•	•	•	•	•	•	•	•	•	•	•	•
190-526-000	Lawn rake, 102 cm working width, 20 tines	4008423804454	-	•	•	•	•	•	•	•	•	•	•	•	•	•	•	•	•	•	•	•	•
196-094-000	Tow-Lawn Aerator, 102 cm working width, 10 galvanised aerator stars	4008423896367	-	•	•	•	•	•	•	•	•	•	•	•	•	•	•	•	•	•	•	•	•
196-552A000	Deflector for all XT series rear discharge lawnmowers	4008423899641	-							•		•		•	•	•					•		
196-750A678	Deflector for LT Series rear discharger system	4008423836097	-	•		•		•															
196-399-000	Rear hitch for LT series with rear discharge	4008423914733	-	•		•		•															
FRONT ACCESSORIES																							
OEM-190-679	Front bumpers – for all LT Series lawn tractors	4008423917819	-	•	•	•	•	•	•														
196-564-000	Bull bar bumper for XT Series	4056494171210	-	•	•	•	•	•	•	•	•	•	•	•	•	•	•	•	•	•	•	•	•
OEM-190-833	117 cm dozer blade for LT Series	4008423807684	-	•	•	•	•	•	•														
196-584-000	Installation Kit – for attaching OEM-190-833 in the XT Series	4008423879629	-							•	•	•	•	•	•	•	•	•	•	•	•	•	•
196-718-678	Universal rubber lip suitable for all dozer blades	4008423815368	-	•	•	•	•	•	•														
19A30017OEM	117 cm dozer blade for XT Series	0037049957309	-	•	•	•	•	•	•	•	•	•	•	•	•	•	•	•	•	•	•	•	•
19A40024100	Snow thrower for XT Series side discharger	0043033573585	-								•		•				•	•	•	•		•	•
19A40045OEM	Snow thrower for XT Series rear discharger	0016918038936	-							•		•		•	•	•					•		
TIELBÜRGER FOR XT SERIES																							
196-603-000	Front attachment sweeper, 120 cm	4008423883510	-							•	•	•	•	•	•	•	•	•	•	•	•	•	•
196-604-000	Hopper for front attachment sweeper	4008423883527	-							•	•	•	•	•	•	•	•	•	•	•	•	•	•
196-606-000	Premium dozer blade, 125 cm	4008423883534	-							•	•	•	•	•	•	•	•	•	•	•	•	•	•
196-607-000	Wheels for Premium dozer blade	4008423883541	-							•	•	•	•	•	•	•	•	•	•	•	•	•	•
196-601-000	Rapid changer without drive – attachment for front premium dozer blade	4008423883497	-							•	•	•	•	•	•	•	•	•	•	•	•	•	•
196-602-000	Rapid changer without drive – attachment for front attachment sweeper	4008423883503	-							•	•	•	•	•	•	•	•	•	•	•	•	•	•
196-608-000	Drive set rear discharge	4008423885194	-							•		•		•	•	•					•		
196-609-000	Drive set side discharge	4008423885200	-							•		•		•	•	•	•	•	•	•	•	•	•
196-610-000	Mounting frame rear discharge	4008423885217	-							•		•		•	•	•					•		
196-611-000	Mounting frame side discharge	4008423885224	-							•		•		•	•	•	•	•	•	•	•	•	•

MOD. NO.	DESCRIPTION	EAN CODE	PRICE	LT1 NR92	LT1 NS96	LT2 NR92	LT2 NS96	LT3 PR105	LT3 PS107	XT1 OR95	XT1 OS96	XT1 OR106	XT1 OS107	XT2 PR95	XT2 QR106	XT2 PR106	XT2 PS107	XT2 PS117	XT2 ES107	XT2 QS117	XT3 QR106	XT3 QS127	XT3 QS137	
LAWN TRACTORS ACCESSORIES																								
MULCHING																								
OEM-190A116	Mulch Kit (without blades)	4008423819632	-		•		•		•															
196-749A678	Mulch Kit (without blades)	4008423836080	-	•		•		•																
196-550-000	Mulch Kit without blade for 106 cm mowing decks	4008423875652	-									•			•	•					•			
196-551-000	Mulch Kit without blade for 95 cm mowing decks	4008423875669	-							•				•										
196-560-000	Mulching blade for Mulch Kit (196-550-000)	4008423875683	-									•			•	•					•			
196-561-000	Mulching blade for Mulch Kit (196-551-000)	4008423875690	-							•				•										
SNOW CHAINS																								
196-658-699	Snow chains for 20" x 8,0" tyres with adapter	4008423824797	-		•		•		•		•		•					•	•	•	•			
196-898-699	Snow chains for 18" x 9,5" tyres with adapter	4008423813678	-	•		•		•																
490-241-0025	Snow chains for 22" x 9", 5" x 12" and 23" x 9", 5" x 12"	0037049945597	-																			•	•	
ADDITIONAL ACCESSORIES																								
196-721A678	Rear wheels with traction tyres, 18" x 9,5"	4008423816891	-	•		•		•		•	•	•	•	•	•	•	•	•	•	•	•			
196-967-678	Battery charger for LR, LT and XT Series	4008423835694	-	•	•	•	•	•	•	•	•	•	•	•	•	•	•	•	•	•	•			
2024-U1-0003	Tarpaulin for lawn tractors, size L	4008423806441	-		•		•																	
2024-U1-0004	Tarpaulin for lawn tractors, size XL	4008423823882	-							•	•	•		•	•	•								

MOD. NO.	DESCRIPTION	EAN CODE	PRICE	LR1 MS76	LR1 MR76	LR2 NS76	LR2 NR76	LR2 ES76
MINI-RIDER								
196-334-600	Mulch Kit/deflector with blade for 76 cm decks	4008423862829	-	•	•	•	•	•
196-707-678	Mulch Kit/deflector with blade for 60 cm decks	4008423811797	-					
19A30014OEM	Dual-bag 115 l grass catcher without blades for 76 cm decks	0043033563029	-		•		•	•
196-397-000	Rear hitch for LR series with side discharge	4008423914719	-	•		•		•
196-398-000	Rear hitch for LR series with rear discharge	4008423914726	-		•		•	

MOD. NO.	DESCRIPTION	EAN CODE	PRICE	LM1 AP46	LM1 AR46	LM1 CR53	LM1 DP53	LM2 DR46s	LM2 DR46es	LM2 DR53s	LM3 CR46s	LM3 CRC46s	LM3 CR53s	LM3 DR53es	LC3 DP56
LAWN MOWERS															
196-588-678	Mulch Kit for 46 cm mowing decks LM Series	4008423855913	-	•	•			•	•		•	•			
196-589-678	Mulchkit for 53 cm mowing decks LM Series, until model year 2020	4008423855920	-			•	•			•			•	•	
196-590-678	Mulchkit for 53 cm mowing decks LM Series, from model year 2021 onwards	4008423918748	-			•	•			•			•	•	
1182-WS-0001	10 pcs. of cutting line AF3.20, cut to 3,9 mm x 47 cm length for trimmer	4056494116662	-												•

MOD. NO.	DESCRIPTION	EAN CODE	PRICE	XR5 1000	XR5 2000	XR5 3000	XR5 4000
ROBOTIC MOWERS							
MRK0067B	Perimeter wire (650 metres on spool)	7290109391458	-	•	•	•	•
122-003-603	Installation Kit large (for max. 2.500 m²) 250 m wire, 350 pegs	4008423885163	-	•	•	•	•
122-002-603	Installation Kit medium (for max. 1.200 m²), 150 m wire, 200 pegs	4008423885156	-	•	•	•	•
122-001-603	Installation Kit small (for max. 400 m²) 100 m wire, 150 pegs	4008423885149	-	•	•	•	•
122-085-603	RoboHome for XR5 models	4008423917895	-	•	•	•	•
122-105-603	Blade kit XR5 models	4008423917901	-	•	•	•	•



MOD. NO.	DESCRIPTION	EAN CODE	PRICE	LH5 H60	LH5 HT60	LH5 B60	LH5 C60	LM5 E 51 R
60V MAX AKKU-SYSTEM								
49AP601-603	60V MAX battery, 2,5 Ah	4008423917383	-	•	•	•	•	
49AP602-603	60V MAX battery, 5,0 Ah	4008423917390	-					•
49AL601-603	60V MAX Charger, 2,0 A	4008423917406	-	•	•	•	•	•

MOD. NO.	DESCRIPTION	EAN CODE	PRICE	XS2 61 SWE	XS3 66 SWE	XS3 71 SWE	XS3 76 SWE	XS3 76 TDE
WINTER ACCESSORIES								
7011-M6-0010	Shear bolt for all snow throwers	4008423821871	-	•	•	•	•	•
2024-U1-0005	Tarpaulin for all snow throwers	4047427520458	-	•	•	•	•	•
6012-X1-0040	Winter engine oil, contents: 1.000 ml	4008423821987	-	•	•	•	•	•
396-004-678	Dozer blade for all 2X and 3X Series snow throwers	4008423811025	-	•	•	•	•	•
6012-X1-0045	Easy Run fuel stabiliser, 250 ml	4008423852387	-	•	•	•	•	•
396-005-678	Rubber lip – universal for all dozer blades	400842815837	-	•	•	•	•	•

MOD. NO.	DESCRIPTION	EAN CODE	PRICE	XZ3 122	XZ6 S107	XZ6 S117	XZ6 S127	XZ5 107	XZ5 127	XZ5 137	XZ7 L122	XZ7 L152i
ZERO-TURN ACCESSORIES												
19C70020100	Twin bagger, 200 l, for XZ2 117i	0037049957835	-									
19A70043100	Twin bagger, 200 l, for XZ2 127	0043033565085	-									
19A70040100	Triple bagger, 300 l, for XZ3 122	0043033565054	-	•								
19A70054100	Cub Cadet RZT Twin Bagger, 107 cm, 230 litres for XZ5	4008423913361	-					•	•	•		
19A70055100	Cub Cadet RZT Twin Bagger, 127 / 137 cm, 230 litres for XZ5	0037049965410	-					•	•	•		
49A70001100	Triple Bagger 380 l, for XZ7 with 122cm cutting width	4008423917987	-								•	•
49A70002100	Triple Bagger 380 l, for XZ7 with 152cm cutting width	4008423917994	-								•	•
490-950-C062	Weight kit for use with the grass catcher of all XZ6 models	0889021302702	-		•	•	•					
19A70025100	Hitch for all XZ models	0043033565054	-	•	•	•	•	•	•	•	•	•

MOD. NO.	DESCRIPTION	EAN CODE	PRICE	Z1 137	Z5 152	Z7 183	Z9 183id
PRO Z ACCESSORIES							
490-241-0026	Snow chains for Z1	0037049945603	-	•			
490-241-0036	Snow chains for Z5 and Z7	0037049951123	-		•	•	
59B30036150	Dozer blade for Z5 and Z7	0043033580255	-		•	•	
19B70045100	Electric deck lift for Z1	4008423881189	-	•			
19A70019100	Heavy duty lawn striping Kit for Z1	0043033542109	-	•			
59A30052150	Heavy duty lawn striping Kit for Z7 and Z9	0889021121587	-		•		•

MOD. NO.	DESCRIPTION	EAN CODE	PRICE
INDEPENDENT ACCESSORIES			
19B40026100R	Cub Cadet trailers, max. 450 kg	4008423887013	-
19A40027OEM	Guide handle for trailer	0037049959068	-
19A40030OEM	Equipment holder for trailer	0037049959082	-
196-558-603	Fuel canister, 10 litre	4008423877540	-



